

CLASS "C" MOTOR HOME
BY FLEETWOOD.

1998

©1997 by Fleetwood Enterprises, Inc. All rights reserved. No part of this publication may be reproduced or transmitted in any form or by any means, electronic or mechanical, including photocopying, recording, or by any information storage or retrieval system without written permission from Fleetwood Enterprises, Inc.

LIMITED ONE-YEAR/THREE-YEAR WARRANTY

For Motor Homes Manufactured by subsidiaries of Fleetwood Enterprises, Inc.,
sold in the United States and Canada

Your new motor home, including the structure, plumbing, heating and electrical systems, and all appliances and equipment installed by the manufacturer, is warranted under normal use to be free from manufacturing defects in material or workmanship.

COVERAGE PROVIDED

The warranty extends to the first retail purchaser and his transferee(s) and begins on the date of original retail delivery or the date the motor home is first placed into service as a rental, commercial or demonstrator unit (whichever occurs first). The warranty extends for the following periods:

1. For all defects (other than structural) the warranty extends for a period of one year from such date or until the unit has received 15,000 total miles of use as determined by the mileage shown on the odometer (whichever occurs first).
2. For structural defects, 3 years; structural defects are limited to the following: roof structure, sub-floor structure, exterior walls, interior walls and ceilings.

Written notice of defects must be given to the selling dealer or manufacturer not later than ten (10) days after the expiration of the warranty period.

The owner is responsible for normal maintenance as described in the Owner's Manual; however, minor adjustments (such as adjustments to the interior or exterior doors, LP regulator pressure, cabinet latches, TV antenna control, etc.) will be performed by the dealer during the first 90 days of warranty coverage. Thereafter, such adjustments are the responsibility of the owner as normal maintenance unless required as a direct result of repair or replacement of a defective part under this warranty.

OWNER'S OBLIGATIONS

If a problem occurs which the owner believes is covered by this warranty, the owner shall contact the selling dealer, or other authorized dealer, giving him sufficient information to resolve the matter. The owner shall deliver the motor home to the dealer or manufacturing plant location for warranty service.

WARRANTY

DEALER'S OBLIGATIONS

By agreement with the manufacturer, the dealer is obligated to maintain the motor home prior to retail sale, to perform a detailed pre-delivery inspection and to repair or replace any parts necessary to correct defects in material or workmanship.

WHEN THE DEALER DOES NOT RESOLVE THE PROBLEM

If the dealer is unable or unwilling to resolve a problem which the owner is convinced is covered by the warranty, he should contact the manufacturing plant at the address listed below and provide the manufacturer with a description in writing of the problem and attempts made to resolve it.

MANUFACTURING PLANT OBLIGATIONS

Upon receipt of notice of a claim, where the dealer was unable or unwilling to resolve the problem, the manufacturing plant will repair or replace any parts necessary to correct defects in material or workmanship or will take other appropriate action as may be required.

WHEN THE MANUFACTURING PLANT DOES NOT RESOLVE THE PROBLEM

If the representatives of the manufacturing plant are unable to resolve the problem and the owner is convinced that it is covered by the warranty, the owner should call the toll-free number listed below to describe the problem and the attempts made to resolve it.

WHAT IS NOT COVERED BY THE EXPRESS WARRANTY

This warranty does not cover:

1. The automotive system (including the chassis and drive train), tires and batteries, which are covered by the separate warranties of the respective manufacturers of these components.
2. Defects caused by or related to:
 - a. Abuse, misuse, negligence or accident;
 - b. Failure to comply with instructions contained in the Owner's Manual;

WARRANTY

- c. Alteration or modification of the motor home;
- d. Environmental conditions (salt, hail, chemicals in the atmosphere, etc.)
3. Normal deterioration due to wear or exposure, such as fading of fabrics or drapes, carpet wear, etc.
4. Normal maintenance and service items, such as light bulbs, fuses, wiper blades, lubricants, etc.
5. Motor homes on which the odometer reading has been altered.
6. Transportation to and from dealer or manufacturing plant location, loss of time, inconvenience, commercial loss, loss of use, towing charges, bus fares, vehicle rental, incidental charges such as telephone calls or hotel bills, or other incidental or consequential damages.

Some states do not allow the exclusion or limitation of incidental or consequential damages, so the above limitation or exclusion may not apply to you.

This warranty gives you specific legal rights, and you may also have other rights which vary from state to state.

The manufacturer is not responsible for any undertaking, representation or warranty made by any dealer or other person beyond those expressly set forth in this warranty.

Brand Name: _____

Model: _____

Serial No.: _____

Manufacturing Plant: _____

For Customer Service assistance, contact:

Fleetwood Parts & Service
PO Box 5700
Riverside, CA 92507
(800) 322-8216

Fleetwood Parts & Service
PO Box 1007
Decatur, IN 46733
(800) 322-8216

Our forest product suppliers have advised that urea-formaldehyde is used in the production of particle board, hardwood plywood or paneling which they supply us and which we utilize in our finished product. These suppliers have requested that we communicate this to our customers.

IMPORTANT NOTICES



WARNING

This product is manufactured with urea-formaldehyde resin. Formaldehyde vapor may in some people cause headaches, eye, nose and throat irritation, and aggravation of allergies and respiratory problems, such as asthma. Proper ventilation should reduce the risk of such problems.

Champion International Corporation



WARNING

This product is manufactured with a urea-formaldehyde resin and will release small quantities of formaldehyde. Formaldehyde levels in the indoor air can cause temporary eye and respiratory irritation, and may aggravate respiratory conditions or allergies. Ventilation will reduce indoor formaldehyde levels.

Weyerhaeuser Corporation



WARNING

This motor home contains components containing or manufactured with 1,1,1 Trichloroethane, a substance that may be harmful to the public health and environment by destroying ozone in the upper atmosphere.



WARNING

Irritant: This product contains a urea-formaldehyde resin and may release formaldehyde vapors in low concentrations. Formaldehyde can be irritating to the eyes and upper respiratory system of especially susceptible persons such as those with allergies or respiratory ailments. Use with adequate ventilation. If symptoms develop, consult your physician.

Georgia-Pacific Corporation

Ventilation is important in maintaining a comfortable environment and we direct your attention to the discussion of ventilation contained in your Owner's Manual.

We are required to tell you consumer information provided by the National Fire Prevention Association (NFPA) and the American National Standards Institute (ANSI). The information and warnings found on these pages may also be found in other chapters of this *Owner's Manual*. Please see the *LP Gas System* and *Appliances* chapters for other safety and operating information.

SAFETY REGULATIONS REGARDING LP GAS SYSTEMS AND LP GAS APPLIANCES



WARNING

Do not bring or store LP gas containers, gasoline or other flammable liquids inside the vehicle because a fire or explosion may result.

A warning label has been located near the LP gas container. This label reads: DO NOT FILL CONTAINER(S) TO MORE THAN 80-PERCENT OF CAPACITY.

Overfilling the LP gas container can result in uncontrolled gas flow which can cause fire or explosion. A properly filled container will contain approximately 80- percent of its volume as liquid LP gas.

The following label has been placed in the vehicle near the range:

IF YOU SMELL GAS:

- 1. Extinguish any open flames, pilot lights, and all smoking materials.**
- 2. Do not touch electrical switches.**
- 3. Shut off the gas supply at the tank valve(s) or gas supply connection.**
- 4. Open doors and other ventilation openings.**
- 5. Leave the area until the odor clears.**
- 6. Have the gas system checked and leakage source corrected before using again.**

LP gas regulators must always be installed with the diaphragm vent facing downward. Regulators that are not in compartments have been equipped with a protective cover. Make sure that regulator vent faces downward and the cover is kept in place to minimize vent blockage which could result in excessive gas pressure causing fire explosion.

**SAFETY REGULATIONS
REGARDING
LP GAS SYSTEMS AND
LP GAS APPLIANCES**

 **WARNING**

It is not safe to use cooking appliances for comfort heating. Cooking appliances need fresh air for safe operation.

Before operation:

1. Open overhead vent or turn on exhaust fan, and
2. Open window.

This warning label has been located in the cooking area to remind you to provide an adequate supply of fresh air for combustion. Unlike homes, the amount of oxygen supply is limited due to the size of the recreational vehicle, and proper ventilation when using the cooking appliance(s) will avoid dangers of asphyxiation. It is especially important that cooking appliances not be used for comfort heating as the danger of asphyxiation is greater when the appliance is used for long periods of time.

 **WARNING**

Portable fuel-burning equipment, including wood and charcoal grills and stoves, shall not be used inside this recreational vehicle. The use of this equipment inside the recreational vehicle may cause fires or asphyxiation.

 **WARNING**

LP gas containers shall not be placed or stored inside the vehicle. LP gas containers are equipped with safety devices which relieve excessive pressure by discharging gas to the atmosphere.

This page intentionally blank.

Table of CONTENTS

WARRANTY SPECIAL NOTICES AND WARNINGS

INTRODUCTION	01-1
WARRANTIES	01-2
REPORTING SAFETY DEFECTS	01-4
OWNER'S INFORMATION PACKAGE	01-5
CHASSIS AND VEHICLE IDENTIFICATION	01-6
ON THE ROAD	02-1
MOTOR HOME LOADING	02-1
<i>Responsibility for Proper Loading</i>	02-1
<i>SOME DEFINITIONS FIRST</i>	02-1
<i>TOWING A VEHICLE OR TRAILER</i>	02-4
<i>CARRYING CAPACITY AND LOAD DISTRIBUTION</i>	02-5
<i>HOW TO WEIGH YOUR LOADED MOTOR HOME</i> <i>Without a TRAILER OR OTHER TOWED LOAD</i>	02-6
<i>HOW TO WEIGH YOUR LOADED MOTOR HOME</i> <i>With a TRAILER OR OTHER TOWED LOAD</i>	02-7
<i>LOADING TIPS</i>	02-8
TIRES	02-9
<i>TIRE INFLATION</i>	02-9
<i>TIRE REPLACEMENT</i>	02-10
<i>IF YOU GET A FLAT TIRE</i>	02-10
<i>SPARE TIRE CARRIER</i>	02-10
<i>CHANGING A FLAT TIRE</i>	02-11
SEATS AND SEAT BELTS.....	02-11
<i>DRIVER/PASSENGER SEATS</i>	02-11
<i>SEAT BELTS</i>	02-12
<i>Child RESTRAINT</i>	02-12

Table of CONTENTS

DRIVING AND PARKING.....	02-13
FUEL AND FUEL SYSTEMS.....	02-14
<i>Fuel Fill</i>	02-14
<i>Fuel Types and Vapor Lock</i>	02-15
GENERAL CHASSIS TOPICS.....	02-16
<i>VARIABLE SPEED ENGINE FAN</i>	02-16
<i>EXHAUST SYSTEM HEAT</i>	02-16
CARBON MONOXIDE SAFETY PRECAUTIONS.....	02-17
<i>CARBON MONOXIDE DETECTOR</i>	02-18
EMERGENCY TOWING.....	02-18
ATTACHING ACCESSORIES TO YOUR MOTOR HOME.....	02-19
ENGINE TEMPERATURE GAUGES.....	02-19

LIVING WITH YOUR MOTOR HOME03-1

MANUAL ENTRY STEPS.....	03-1
POWER ENTRY STEPS.....	03-1
ENTRY ASSIST HANDLE.....	03-2
ENTRY DOORS AND SCREENS.....	03-2
WINDOWS.....	03-2
<i>EMERGENCY Exit Window</i>	03-3
<i>Side Slider Windows</i>	03-3
SUN VISORS.....	03-3
WINDOW SHADES.....	03-3
Mini-Blinds.....	03-4
STORAGE.....	03-4
<i>EXTERIOR COMPARTMENTS</i>	03-4
<i>INTERIOR STORAGE</i>	03-5
INTERIOR AND FURNISHINGS.....	03-5
<i>DINETTE CONVERSION</i>	03-5
<i>SOFA/LOUNGE CONVERSION</i>	03-6

Table of CONTENTS

<i>Folding Doors/Privacy Curtain Dividers</i>	03-6
<i>Interior Lighting</i>	03-6
<i>Overhead Vents</i>	03-7
MONITOR PANEL.....	03-7
EFFECTS OF LONG TERM OCCUPANCY	03-8
<i>Ventilation and Controlling Condensation</i>	03-9
FIRE SAFETY.....	03-10
<i>Fire Safety Precautions</i>	03-11
<i>Smoke Detector</i>	03-12

PLUMBING SYSTEMS04-1

FRESH WATER SYSTEM	04-1
<i>City Water Connection</i>	04-2
<i>The Water Pump</i>	04-3
<i>Water Filter</i>	04-4
<i>Troubleshooting the Fresh Water System</i>	04-4
<i>Leaks</i>	04-4
<i>Sanitizing the Fresh Water System</i>	04-5
<i>Exterior Shower (Some Models Only)</i>	04-6
WASTE WATER SYSTEM	04-6
<i>Toilet</i>	04-6
<i>Draining the Holding Tanks</i>	04-7
<i>Holding Tank Care</i>	04-9

ELECTRICAL SYSTEMS05-1

CHASSIS ELECTRICAL SYSTEM	05-1
<i>Chassis Bulbs and Fuses</i>	05-1
12-Volt COACH SYSTEM	05-1
<i>Auxiliary Start System</i>	05-2
<i>Battery Inspection and Care</i>	05-2

Table of CONTENTS

<i>BATTERY CHARGING</i>	05-3
<i>SELECTING A REPLACEMENT BATTERY</i>	05-4
120-Volt SYSTEM	05-4
<i>POWER CONVERTER</i>	05-4
<i>GROUND FAULT CIRCUIT INTERRUPTER</i>	05-4
COACH FUSES AND CIRCUIT BREAKERS.....	05-5
GENERATOR	05-6
<i>GENERATOR FUEL SUPPLY</i>	05-6
<i>GENERATOR OPERATION</i>	05-6
<i>GENERATOR OPERATING SAFETY PRECAUTIONS</i>	05-7
ELECTRICAL SYSTEM WIRING.....	05-8

LP GAS SYSTEM06-1

LP GAS SAFETY PRECAUTIONS.....	06-2
SYSTEM COMPONENTS	06-4
<i>HOSES</i>	06-4
<i>LP GAS REGULATOR</i>	06-4
Using LP GAS SYSTEM AT LOW TEMPERATURES	06-5
Filling LP GAS TANKS	06-6
LP GAS SYSTEM LEAK CHECKS	06-7
LP LEAK DETECTOR.....	06-8
Lighting LP GAS APPLIANCES.....	06-9

Appliances07-1

WATER HEATER.....	07-1
REFRIGERATOR.....	07-2
<i>REFRIGERATOR DOOR PANELS</i>	07-2
FURNACE.....	07-2
RANGE	07-3
RANGE EXHAUST HOOD.....	07-3

Table of CONTENTS

DUCTED AIR CONDITIONER	07-4
ENTERTAINMENT EQUIPMENT.....	07-5
<i>120-Volt TV and VCR</i>	07-5
<i>120/12-Volt Television</i>	07-5
TV ANTENNA	07-5
TV AND RADIO INTERFERENCE	07-6
MISCELLANEOUS APPLIANCES	07-7
MAINTENANCE	08-1
EXTERIOR	08-2
<i>STAINS</i>	08-2
<i>Windows, Doors, VENTS AND Locks</i>	08-3
RUBBER ROOF SYSTEM	08-3
<i>CLEANING</i>	08-3
<i>CARE</i>	08-3
<i>SEALANT RENEWAL</i>	08-4
<i>DOOR, Window, Roof COMPONENT</i> <i>AND Molding RESEALING</i>	08-4
INTERIOR.....	08-2
<i>FABRICS</i>	08-5
<i>LAMINATE TOP CARE</i>	08-5
<i>WALLS AND CEILING PANELS</i>	08-5
<i>BATHTUB AND PLASTIC SHOWER Stall</i>	08-6
<i>FLOORS AND CARPETING</i>	08-6
<i>ENGINE ACCESS</i>	08-6
MAINTENANCE CHECKLIST.....	08-6
MAINTENANCE CHART	08-7

Table of CONTENTS

MOTOR HOME STORAGE	09-1
STORAGE CHECKLISTS.....	09-1
<i>SHORT-TERM STORAGE</i>	09-1
<i>LONG-TERM STORAGE</i>	09-3
WINTERIZATION.....	09-5
<i>WATER SYSTEM WINTERIZING</i>	09-5
REACTIVATING THE MOTOR HOME AFTER STORAGE.....	09-8
 GLOSSARY	 10-1

INTRODUCTION

Welcome to the recreational vehicle life-style and the growing family of motor home owners. We sincerely thank you for choosing a Fleetwood motor home!

Your motor home has been designed to provide you with years of carefree, pleasant traveling and vacationing. Your motor home conforms with, or exceeds, the *American National Standards Institute A119.2, CSA Standard Z-240* (units built for Canada), and applicable *Federal Motor Vehicle Safety Standards*. These standards establish the plumbing, heating, electrical and other requirements for performance and safety. Compliance with *ANSI* and *CSA* standards is indicated by the seal attached just outside the entry door.

Like all finely crafted equipment, your motor home will require care and regular maintenance in order to deliver maximum value and performance. The dealer will give you basic operating and maintenance instructions; however, supplement this by reading all instructional material furnished with the motor home in the *Owner's Information Package* and *Chassis Operator's Manual*. This information outlines important areas of maintenance and provides a maintenance schedule for you to follow for safe, trouble free service from your motor home. Study these instructions carefully before you operate the motor home for the first time. A good working knowledge of your motor home and how to care for it will help you enjoy many miles and years of recreational living.



NOTE

This manual describes many features of your motor home and includes instructions for its safe use. This manual, including photographs and illustrations, is of a general nature only. Some equipment and features described or shown in this manual may be optional. Because of the continuous program of product improvement conducted by Fleetwood, it is possible that recent product changes may not be included. The instructions included in this manual are intended as a guide, and in no way extend the responsibilities of the manufacturing subsidiary, parent company or affiliates beyond the standard written warranty as presented in this manual.

INTRODUCTION

In this manual, statements preceded by the following words are of special significance:

WARNING

means that there is the possibility of personal injury to yourself and others.

CAUTION

means that there is the possibility of damage to the vehicle.

NOTE

indicates points of particular interest for more efficient and convenient operation.

Please pay close attention to these statements while you read this manual.

If you have any questions regarding operation, maintenance, or service, please contact your dealer immediately so he can assist you. Your dealer's Service or Sales Department will handle any normal problems which might occur.



NOTE

This product is designed for recreational use and short term occupancy only. It is not designed or intended to be used as permanent housing. Use of this product for long term or permanent occupancy may lead to premature deterioration of interior finishes, fabrics, carpeting, drapes, appliances and fixtures. Damage or deterioration due to long term occupancy is not be considered normal, and will under the terms of the warranty constitute misuse, abuse, or neglect, thereby reducing your warranty protection. Before considering this motor home for long term occupancy, consult the relevant sections in this manual.

Your motor home is covered by one of the most comprehensive warranty programs in the RV industry. Please refer to the warranty in the front of this manual. It explains your rights and obligations, as well as the rights and obligations of the dealer and manufacturer. Please read this section carefully. You will be better informed in case you have a warranty-related problem, and your dealer will be better able to get you on the road again. If you have any questions about the warranty or what it does or does not cover, please contact your dealer.

WARRANTIES

The materials in your *Owner's Information Package* contain warranty information and operating instructions on the various appliances and components in your motor home. Warranty registration cards for these items should be filled out and mailed as soon as possible after you take delivery of your motor home. If you do not have operating instructions for a particular appliance, contact your dealer.

You will automatically receive an *Ownercare Card* approximately 3-4 weeks after delivery of your new motor home. This plastic card is imprinted with your name, the motor home serial number, and manufacturing subsidiary location. If your motor home ever needs warranty service, present this card to the dealer.

The motor home has been thoroughly inspected before shipment. Your dealer is responsible for performing a complete predelivery inspection of the chassis and all motor home components as specified in the predelivery checklists supplied by the motor home and chassis manufacturers. *You should receive a copy of these completed checklists from your dealer when your motor home is delivered to you.*

As a part of the predelivery inspection procedure, the dealer is responsible for road testing the motor home, noting and correcting any steering problems before delivery. ***Fleetwood and its subsidiaries will not be responsible for front end alignment after this predelivery inspection is done.***

You should return your motor home to the selling dealer for warranty service. If this is not possible, you may contact any other authorized Fleetwood motor home dealer. The service department at any of the locations listed at the back of this manual can help you find a dealer in your area.

INTRODUCTION

If, for some reason, a problem is not handled to your satisfaction:

1. Discuss any warranty-related problems directly with the manager and/or owner of the dealership, giving them an opportunity to help the service department resolve the matter for you.
2. If a problem arises that has not been resolved to your satisfaction by your local dealer, contact the manufacturing subsidiary service facility. The locations are listed in this manual. Please contact the one nearest you.
3. We sincerely believe that your dealer and the factory representative will be able to solve any problem which might arise. If their combined efforts are not satisfactory, please send a letter describing the circumstances to:

**Motor Home Division
Consumer Affairs Department
P.O. Box 7638
Riverside, CA 92513-7638**

Please include the brand name and serial number of your motor home. The serial number is located on the identification tag next to the driver's cab door.

4. If you wish to call for assistance, please use this toll-free telephone number:

(800) 322-8216

If you believe that your vehicle has a defect which could cause a crash or could cause injury or death, you should immediately inform the *National Highway Traffic Safety Administration (NHTSA)* in addition to notifying Fleetwood Enterprises Consumer Affairs Department.

If *NHTSA* receives similar complaints, it may open an investigation, and if it finds that a safety defect exists in a group of vehicles, it may order a recall and remedy campaign. However, *NHTSA* cannot become involved in

**REPORTING
SAFETY
DEFECTS**

individual problems between you, your dealer or Fleetwood's manufacturing subsidiary.

To contact *NHTSA*, you may either call the *Auto Safety Hotline* toll-free at 1-800-424-9393 (or 366-0123 in Washington, D.C. area) or write to:

NHTSA
U.S. Department of Transportation
Washington, D.C. 20590

You can also obtain other information about motor vehicle safety from the Hotline.

This package contains valuable documents about your motor home and its equipment and systems. This *Owner's Manual* is in the package. Since this manual does not cover every possible detail of equipment and options installed on or in your motor home, there are booklets and instructional material in the package that will help you safely operate, maintain and troubleshoot those items. Be sure you read all this information and understand the safety and operating instructions included in the package. Additionally, you must follow all maintenance instructions to insure full warranty coverage. If you ever decide to sell or trade your motor home, be sure the new owner gets all the material in this package.

OWNER'S INFORMATION PACKAGE

INTRODUCTION

CHASSIS AND VEHICLE IDENTIFICATION

Two numbers are used to identify the vehicle and components used on the vehicle. The **V.I.N.**, or **Vehicle Identification Number** is the legal identification of the completed vehicle and is the number of the vehicle registration. The V.I.N. is found on the Federal Certification Tag located on the left interior sidewall of the motor home driver compartment. Refer to this number when ordering parts or service from the chassis dealer service center.

The **Fleetwood Identification Number (F.I.N.)** is found on the Fleetwood Motor Homes tag to the left of the main entry door or on the exterior left front side of the motor home. Use this number when ordering parts through your Fleetwood dealer or Service Center.

FEDERAL CERTIFICATION TAG			
MANUFACTURED BY:		DATE OF MFR:	
INCOMPLETE VEHICLE MFD. BY:		DATE OF INC. VEH. MFR:	
GROSS VEHICLE WEIGHT RATING:			
GAWR FRONT			
	WITH:		RIMS
	TIRES AT:	PSI COLD SINGLE	
GAWR INTERMEDIATE			
	WITH:		RIMS
	TIRES AT:	PSI COLD SINGLE	
GAWR REAR			
	WITH:		RIMS
	TIRES AT:	PSI COLD SINGLE	
This vehicle conforms to all applicable Federal Motor Vehicle Safety Standards in effect in:			
VEH. IDENT. NO.:		V.I.N. (Vehicle Identification No.)	
TYPE VEHICLE: MULTI-PURPOSE PASSENGER VEHICLE			
The tires on this unit may be different from those shown above. Check tire sidewalls for maximum inflation pressure. Replacement tires must be rated no less than the axle capacity (GAWR).			

FLEETWOOD®	
MOTOR HOMES	
OF	INC.
PLAN APPROVAL NO.	
F.I.N.	
MFD. ID. NO.	MODEL
DATE OF MFR. MO:	YR:

Located on the left of the main entry door or on exterior left front side of the motor home.

F.I.N. (Fleetwood Identification No.)

Located on the left interior stepwell of the motor home driver compartment.

ON THE ROAD

As the operator of this motor home, you bear the sole responsibility for proper, safe loading. This section will guide you through the steps necessary to properly and safely load your vehicle.

Your motor home chassis is designed to carry a specific maximum weight. This weight includes everything: the weight of the empty motor home itself, all occupants and their belongings, fuel, fresh water, waste water and anything else that may be in or attached to the motor home.

MOTOR HOME LOADING

RESPONSIBILITY FOR PROPER LOADING

Before discussing loading and weighing, we need to explain some common weight terms. We'll use abbreviations in our discussion. These terms are:

SOME DEFINITIONS FIRST

GVWR (Gross Vehicle Weight Rating)*

means the maximum permissible weight of this motor home. The GVWR is equal to or greater than the sum of the Unloaded Vehicle Weight plus the Net Carrying Capacity.

GAWR (Gross Axle Weight Rating)*

means the maximum weight a specific axle is designed to carry.

GCWR (Gross Combined Weight Rating)*

means the value specified by the motor home manufacturer as the maximum allowable loaded weight of this motor home with its towed trailer or towed vehicle.

GTW (Gross Towed Weight)*

means the maximum permissible loaded weight of a trailer or car that this motor home has been designed to tow. This cannot be increased by changing the trailer hitch.

***These ratings are shown on the Carrying Capacity Tag.**

ON THE ROAD

TW (Tongue Weight)*

means the downward force exerted on the hitch ball by the towed vehicle coupler.

UVW (Unloaded Vehicle Weight)*

means the weight of this motor home as built at the factory with full fuel, engine oil and coolants. The UVW does not include cargo, fresh water, LP gas, occupants, or dealer installed accessories.

NCC (Net Carrying Capacity)*

means the maximum weight of all occupants including the driver, personal belongings, food, fresh water, LP gas, tools, tongue weight of towed vehicle, dealer installed accessories, etc., that can be carried by this motor home. NCC is equal to or less than GVWR minus UVW.



WARNING

The loaded motor home with all passengers and driver must not exceed the following:

1. The gross axle weight ratings (GAWRs)
2. The gross vehicle weight ratings (GVWRs)
3. The gross combined weight rating (GCWRs)



NOTE

*The GCWR may be reduced if the towed unit is not equipped with brakes that are actuated with the motor home brakes. The allowable weight of towed units not having brakes is listed in the **Chassis Operator's Manual**.*

Federal and State regulations and requirements governing towing vary widely. Contact the State or Provincial police agency in the area in which you will be operating for information.

*Consult the **Chassis Operator's Manual** for weighing instructions and towing guidelines.*

CARRYING CAPACITY

PRODUCT	YEAR	MODEL	SERIAL NO.
GVWR			LBS.
GCWR			LBS.
FRONT GAWR			LBS.
REAR GAWR (Includes capacity of tag axle if so equipped.)			LBS.
HITCH RATING _____ LBS.	TONGUE WEIGHT _____ LBS.	GTW _____ LBS.	
UVW (DRY WEIGHT) OF FINISHED VEHICLE			LBS.
NET CARRYING CAPACITY			LBS.

GVWR (Gross Vehicle Weight Rating): means the maximum permissible weight of this motor home. The GVWR is equal to or greater than the sum of the Unloaded Vehicle Weight plus the Net Carrying Capacity.

GCWR (Gross Combination Weight Rating): means the value specified by the motor home manufacturer as the maximum allowable loaded weight of this motor home with its towed trailer or towed vehicle.

GAWR (Gross Axle Weight Rating): means the maximum permissible loaded weight a specific axle is designed to carry.

GTW (Gross Towed Weight): means the maximum permissible loaded weight of a trailer or car that this motor home has been designed to tow. This cannot be increased by changing the trailer hitch.

Tongue Weight: The maximum permissible downward force exerted on the hitch ball by the towed vehicle coupler.

UVW (Unloaded Vehicle Weight): means the weight of this motor home as built at the factory with full fuel, engine oil, and coolants. The UVW does not include cargo, fresh water, LP gas, occupants or dealer installed accessories.

NCC (Net Carrying Capacity): means the maximum weight of all occupants including the driver, personal belongings, food, fresh water, LP gas, tools, tongue weight of towed vehicle, dealer installed accessories, etc., that can be carried by this motor home. Normal variation of materials may cause the Net Carrying Capacity to be 200 lbs. higher or lower than stated. (NCC is equal to or less than GVWR minus UVW.)

This motor home is capable of carrying up to _____ gallons of fresh water (including water heater) for a total of _____ pounds.

Reference: Weight of fresh water is 8.33 lbs./gal.; Weight of LP gas is 4.5 lbs./gal. (average).

WARNING: The Heaviest Loaded Motor Home With All Passengers, Goods, Water, Driver And Towed Vehicle Must Not Exceed Any Of The Following:

1. The gross vehicle weight rating (GVWR).
2. The gross combination weight rating (GCWR).
3. The front/rear gross axle weight ratings (GAWR'S).

CONSULT OWNER'S MANUAL FOR WEIGHING INSTRUCTIONS AND TOWING GUIDELINES.

W15-2013 10/95

Wardrobe Door Tag with Weight Ratings

ON THE ROAD

You must consider other important weight factors if you expect to pull a trailer, tow dolly, or another vehicle behind your motor home. These factors have limitations. These factors are:

- » **GCWR—Gross Combined Weight Rating**
- » **GTW—Gross Towed Weight**
- » **TW—Maximum Tongue Weight**
- » **GAWR-Rear—Gross Axle Weight Rating-Rear axles or axles (if equipped with tag axles)**

The ratings for these factors are all listed on the wardrobe door tag.

If you expect to pull a vehicle with your motor home, there are additional guidelines that you must follow:

- » ***Do not use a load equalizing hitch. It could cause structural damage to the motor home frame components.***
- » ***Limit the tongue weight of the trailer or towing device to the Maximum Towed Weight as listed on the ratings tag. Heavier tongue weights can damage your motor home frame and body, cause unstable driving and handling characteristics, and will restrict your coverage under the Ownercare warranty.***
- » ***Do not tow a vehicle weighing more than the GTW listed on the wardrobe door tag. Heavier towed loads can cause braking problems, damage the motor home structure or drive train, cause unstable driving or handling characteristics, and restrict your coverage under the Ownercare warranty. Changing the trailer hitch will not increase the tow capacity of the motor home.***
- » ***Consult the Chassis Operator's Manual, state and local codes for the maximum unbraked vehicle weight. If your towed vehicle exceeds the listed weight, then the towed vehicle will need its own operational brakes.***

TOWING A VEHICLE OR TRAILER

(“TOWED LOAD”)



NOTE

Some states and provinces require brakes and safety chains on towed vehicles. Consult the proper authorities in the states or provinces through which you will be traveling.

The way your motor home handles will be affected by the way the towed unit is loaded. If the tongue weight is too light in relation to the GTW, handling problems can result. Careful load planning and safe experimentation with different loading patterns can help improve motor home handling stability and make your driving and towing experience more enjoyable.

 WARNING
Do not exceed the rated load of the motor home, or the rated load of any axle. Exceeding the GVWR, GAWR, GCWR or GTW of your motor home will reduce your warranty protection, can cause undesirable handling characteristics and may create a safety hazard.

The allowable carrying capacity of the motor home is the difference between the GVWR and the weight of the empty motor home. When the motor home is being designed, the number and size of storage compartments, the liquid tank capacities and number of belted seating positions are maximized for value and convenience. If you fill all liquid tanks to capacity, fill all storage compartments and cupboards to maximum volume and fill all available seating positions with passengers, the motor home will be overloaded. The number of passengers and placement of cargo will affect the amount of water and cargo that you can carry (See *Loading Tips*).

CARRYING CAPACITY AND LOAD DISTRIBUTION

In addition to knowing the overall weight that can be safely loaded in or attached to the motor home, you must know how to distribute the weight so that correct amounts of weight are placed on the axles. When the load is properly distributed, your motor home will handle better, and you as the driver will be more confident and comfortable.

If your motor home is improperly loaded, driving will be more uncomfortable and much of your driving attention will be given to correcting vehicle wandering, drift, pull and sudden directional changes caused by wind blasts. If the front axle load is below 80-85% of the front axle capacity,

 NOTE
<i>Net carrying capacities (NCC) of your motor home are specified on a label affixed to the inside of a wardrobe door. The label includes all factory installed options. If other equipment such as leveling jacks, awnings, roof pods, etc., are installed after the motor home leaves the factory, the weight of these items must be subtracted from the total of the passenger and cargo carrying capacities.</i>

ON THE ROAD

these handling discomforts will be more noticeable. Always aim to load your motor home so that the front axle is loaded to at least 80-85% of the front GAWR.

Refer to your local telephone directory to find a public weigh station. The following procedures will help you determine whether your loaded motor home (complete with cargo, fluids, passengers, and driver) is within GAWR, GVWR, and GCWR limits. When you arrive at a weigh station, the attendant will guide you through the correct positioning of the motor home on the scales.

1. Center the front wheels on the scale platform and take a reading. This is the front Gross Axle Weight (Reading 1).
2. Center the entire motor home (all axles) on the scale and take a reading. This is the Gross Vehicle Weight (Reading 2).
3. Center the rear axle on the platform and take a reading. This reading is the rear Gross Axle Weight (Reading 3).

Compare the readings taken on the scales to the weight ratings on the Federal certification tag and wardrobe door tag. Fill in the chart at the back of this manual to aid in comparing weights.

If any readings are higher than the rating, you will have to adjust or remove the load.

HOW TO WEIGH YOUR LOADED MOTOR HOME WITHOUT A TRAILER OR OTHER TOWED LOAD

MOTOR HOME READINGS (from tags)		SCALE READINGS
GVWR _____	MOTOR HOME	Reading 2 _____
Front GAWR _____	FRONT AXLE	Reading 1 _____
Rear GAWR _____	REAR AXLE	Reading 3 _____
Hitch Rating _____	TOWED VEHICLE	Reading 4 _____
GCWR _____	COMBINED VEHICLES	Add 2 and 4 _____

1. Center the front wheels on the scale platform and take a reading. This is the front Gross Axle Weight (Reading 1).

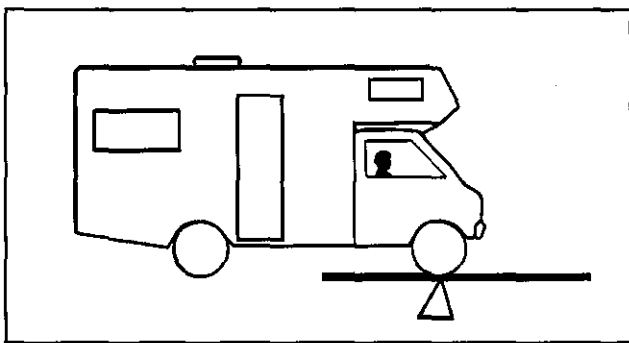

2. Center the entire motor home so that only the motor home is being weighed. Leave the towed load hitched to the motor home, but resting off of the scale (Reading 2).

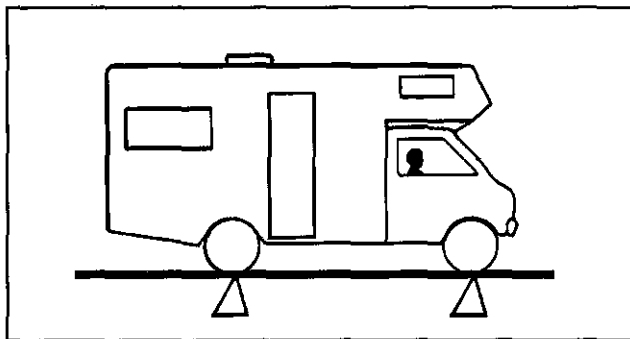

3. Center both the motor home and the towed load combination on the scale and take a reading. This is the Gross Combined Weight (Reading 3).

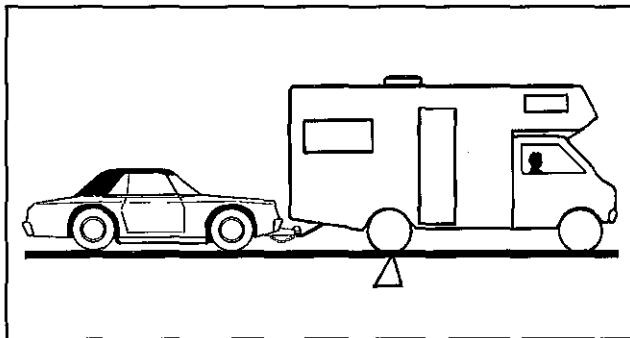

HOW TO WEIGH YOUR LOADED MOTOR HOME WITH A TRAILER OR OTHER TOWED LOAD

ON THE ROAD

4. Subtract Reading 1 from Reading 2. This is the rear Gross Axle Weight.
5. Compare the readings taken on the scales to the weight ratings on the Federal certification tag and wardrobe doortag. Fill in the chart to aid in comparing weights.

If any readings are higher than the rating, you will have to adjust or remove the load.

If you exceed weight ratings, you will:

- » ***Cause damage to the motor home, drive train, or chassis***
- » ***Cause unstable driving and handling characteristics***
- » ***Cause unsafe braking***
- » ***Reduce your warranty protection.***

Since you may load your motor home differently for different trips, loading and weight patterns will change. Periodically reweigh your motor home and log the weights in the back of this manual. Refer to your log as you prepare to load for future trips.

-
- » ***Do not load heavy items in upper cabinets.***
 - » ***Secure and brace items so they wont move during travel, thereby shifting the load.***
 - » ***Do not load heavy items near either end of the motor home or on the bumpers.***
 - » ***Adjust cargo storage to keep the side to side wheel loads as equal as possible.***

LOADING TIPS

- » *Fresh water and waste water weigh over eight pounds per gallon. Carry only as much water as needed for travel use or to balance the load, and whenever possible, empty the holding tanks before traveling.*
- » *Make a loading diagram of your properly loaded motor home. This diagram and your loading log will help you locate where specific items are stored, and will help speed the loading process.*
- » *Store emergency items in a readily accessible location. Include a fire extinguisher, tools, first aid kit, rain gear, flashlight, highway warning devices, and an electric cord with light.*

 **WARNING**

Modification of your vehicle by addition of racks not originally equipped by the manufacturer to carry additional equipment, vehicles or cargo will reduce your warranty coverage and may cause personal injury or property damage.

 **WARNING**

Do not store or carry LP gas containers, gasoline, or other flammable liquids inside your motor home. The containers may leak.

Your motor home is equipped with truck tires. Under normal circumstances and with proper maintenance, you should receive thousands of miles of trouble-free service.

TIRES

For safety and maximum tire life, proper inflation pressure must be maintained. Properly inflated tires also contribute to overall motor home stability and safety. Refer to the tire section in your *Chassis Operator's Manual* for information on maintenance and tire care.

The proper inflation pressures are stated on the Federal Certification Tag located on the sidewall near the driver's seat.

TIRE INFLATION

 **WARNING**

For safety and maximum tire life, check tire pressures often (including the spare). Pay special attention to inside rear duals. Always check pressure when tires are cold, and do not bleed air out of warm tires. Follow the tire pressure instructions in the *Chassis Operator's Manual*.

ON THE ROAD

Replacement tires must be the same size, and have at least the same weight carrying capacity as the original equipment. All tires of the same size and rating may not have the same weight carrying capacity. Consult your tire dealer. The original equipment tires supplied on your motor home have weight carrying capacities to support Gross Axle Weight Ratings (GAWR) as stated on the Federal Certification Tag located on the sidewall near the driver's seat.

TIRE REPLACEMENT



NOTE

Check the wheel lug nut tightness periodically. They could work loose during driving. Check the **Chassis Operator's Manual** for correct lug nut torque and torquing procedure.

In case of sudden tire failure:

- » *Avoid heavy brake application*
- » *Gradually decrease speed*
- » *Hold the steering wheel firmly and move slowly to a safe, off-road place*
- » *Park on a firm level spot*
- » *Turn off the ignition*
- » *Turn on the hazard flasher system*

IF YOU GET A FLAT TIRE

On some models, the spare tire carrier is located under the rear of the motor home between the frame rails.

SPARE TIRE CARRIER



WARNING

Truck tires and wheels are extremely heavy and may weigh 100 pounds or more. Do not attempt to remove the spare tire unless you are capable of handling the weight.

Even with good tire maintenance and normal driving, you may experience a flat tire. Summon professional help through your auto club, travel service, or a local truck service facility. Your motor home is not equipped with a jack or other lifting device. Do not attempt to lift the motor home with a jack. Consult the *Chassis Operator's Manual* for additional information on tire inflation and proper torque.

CHANGING A FLAT TIRE

 **WARNING**

To avoid personal injury and/or property damage if a blowout or other tire damage occurs, obtain expert tire service help. Do not attempt to change the tire yourself.

 **WARNING**

Truck wheels and tires are extremely heavy and may weigh 100 pounds or more. Do not attempt to remove the spare tire unless you are capable of handling the weight.

The driver's and passenger's seats offer different position/comfort adjustments:

SEATS AND SEAT BELTS

Forward/Back - The forward/back lever is located under the front left of the seat. Pull the lever toward the left outside of the seat to unlock. Release the lock lever to secure the seat position.

Recline - The recliner lever is located on the right arm rest.

DRIVER/PASSENGER SEATS

 **WARNING**

Do not adjust the seat position while the vehicle is in motion. You may lose control of the vehicle.

ON THE ROAD

Seat belts are an important safety feature of your vehicle. For your protection, always use your seat belts. The driver's seat and other seats designed to carry passengers while moving have been equipped with seat belts.

Adjust seat belts as follows:

To fasten belt, be sure it is not twisted, then push the tongue end of one belt into the buckle of the mating belt. Be sure it latches. For greatest safety, adjust the belt snugly as low on the abdomen as comfort will allow.

To release the belt, depress the button in the center of the buckle and slide the tongue out of the buckle. Never use a belt for more than one person at a time.

SEAT BELTS

	WARNING
All riders should use seat belts while the vehicle is in motion. Neither seats without safety belts nor beds should be occupied while the vehicle is in motion.	

All vehicle occupants, and especially children, should be restrained whenever riding in vehicles. Holding a child in your arms is not a substitute for seat belts or a child restraint system. Child restraint systems are designed to be secured in the vehicle seats by lap belts. Children could be endangered in a crash if their child restraints are not properly secured in the vehicle.

CHILD RESTRAINT

When using any child restraint system, be sure to read and follow all instructions on installation and use that come with the system.

When securing a child restraint with a lap belt that has no retractor, pull the excess webbing through the adjustment mechanism.

If the child restraint is still not secure, use a different seating position in the vehicle and/or contact your dealer and the child restraint manufacturer for help.

DRIVING AND PARKING

Once you become accustomed to the feel of the controls and the reference points from the driver's seat, you will find driving a motor home comparable to driving your family car. Become familiar with the position of the motor home in traffic, and be cautious when maneuvering to allow for the length and width of the vehicle. Always allow room to corner and to change lanes. Learn to use the side and rear view mirrors to view the road behind.

Remember that your motor home is heavier than a car, making it less maneuverable and harder to stop. Also, because of its greater side surface area, it is more easily affected by cross winds. Allow extra distances for passing and stopping, and drive at a moderate speed, particularly in traffic and in gusty wind conditions.

Driving on winding or mountain roads is not difficult if done with reasonable care. Observe proper vehicle speeds when ascending or descending hills and always operate in the proper transmission range. Downshift on hills to avoid overheating or undue engine loads. Downshift when descending grades. Engine braking power will help control vehicle speed, and relieve some of the strain on the brakes.

Mountain driving or desert temperatures can put extreme demands on chassis components. Under extreme use conditions you may need to turn off the vehicle air conditioner to improve engine and transmission cooling.

Be aware of the extra height of your motor home. Check for low hanging tree branches or other obstructions whenever you drive or park. Avoid low overhangs when pulling in for service. Always check overhead clearances of overpasses and bridges. *This may be particularly important if you drive with the overhead vents open or if the motor home is equipped with a roof air conditioner, roof rack, CB or TV/radio antenna.* Before leaving on a trip, check your route. Some tunnels prohibit motor homes with LP gas systems.

ON THE ROAD

When parking parallel to a curb, be sure to allow for poles or obstructions as the front and rear portions of the motor home swing wider than an automobile. When parking on an incline, turn the front wheel into the curb in the direction of the roll to aid the parking brake. When parking, always shift the transmission to PARK ("P") and set the parking brake, if applicable.

If operating, parking or idling your vehicle off-road is unavoidable:

- » *Be aware that combustible materials could catch fire from the vehicle's hot exhaust system.*
- » *Keep a fire extinguisher handy.*
- » *Avoid driving your vehicle through or over combustible materials such as leaves, grass, vegetation or stubble high enough to touch, catch or collect on its hot exhaust system.*
- » *Parking or idling should be done only in an area where there are no combustible materials under the vehicle.*

	WARNING
Do not park or idle the motor home over combustible materials such as tall grass or dried leaves. This is particularly important if the exhaust system has not been properly maintained. Combustible materials may catch fire from hot exhaust gases, soot or sparks that could escape through corrosion holes or cracks.	

See the *Chassis Operator's Manual* in the *Owner's Information Package* for chassis fuel recommendations. If your motor home is equipped with a generator, see the generator operating instructions in the *Owner's Information Package* for fuel and maintenance recommendations.

FUEL AND FUEL SYSTEMS

The fuel filler cap is located toward the rear of the coach. Modern fuel systems may build up vapor pressure within the tank as the gasoline warms during use or hot weather. Under certain conditions, sudden release of this pressure when removing the gasoline cap can cause gasoline to spray from the fill opening, creating a fire hazard.

FUEL FILL

To protect the gasoline system from excessive pressure or vacuum, or from sudden release of pressure, replace lost or damaged caps with caps of the same design which are available from your Fleetwood motor home dealer.

Clean up fuel spills immediately. Raw fuel spilled on the motor home could damage the exterior finish, and is a serious fire hazard.

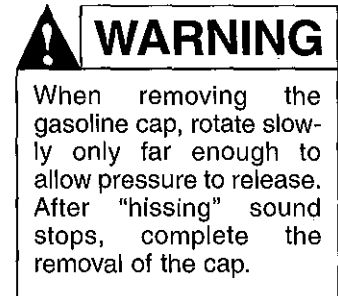

Your motor home's automotive fuel and emissions systems are sophisticated and highly engineered to meet Federal and State emissions standards. They are sometimes sensitive to fuel types and blends, particularly fuels blended for certain altitudes and climates. Fuel suppliers provide customers with the correct fuel for their location and seasonal conditions. Sometimes, though, fuel blended for winter is supplied during summer months.

FUEL TYPES AND VAPOR LOCK

"Vapor lock" occurs when gasoline vaporizes, and vapor pockets block the flow of liquid fuel to the engine. If you experience engine stall or stutter, you may be experiencing vapor lock. If your engine and fuel system are properly tuned and maintained, you should not experience this problem. If vapor lock occurs, the fuel itself could be the cause. If at all possible, check with the service station operator as to the fuel blend before filling your fuel tank. If you purchase your fuel from nationally recognized fuel dealers, your chances of vapor lock can be reduced. If you store your motor home during the winter months, be aware that when you take the vehicle out of storage in the spring or summer, winter fuel may cause vapor lock until it is consumed.

ON THE ROAD

When the engine is under load or requires maximum cooling, the engine fan adjusts and turns faster. The fan may become very noisy at high speed and when maximum cooling is required. High speed fan noise can sometimes be misinterpreted as transmission slippage. This is not the case. High engine speed and temperature conditions, such as pulling away from a stop after long freeway driving, can cause loud fan noise until the engine cools down. This fan noise indicates that the fan is doing what it is supposed to do. This noise is not a defect in the fan or the transmission.

GENERAL CHASSIS TOPICS

VARIABLE SPEED ENGINE FAN

Your motor home engine has been designed to conform to Federal and State emission requirements. To meet these requirements, engine operating temperatures are high. As a result, the engine and exhaust system radiate a great deal of heat.

EXHAUST SYSTEM HEAT

Special heat shields are built into your motor home to protect wiring and other components from possible heat damage caused by the exhaust system. Do not remove these shields, modify the exhaust system, or add additional equipment, such as wiring, plumbing, or other components, which will be affected by exhaust system heat.

Carbon monoxide is a colorless, tasteless, odorless gas. It is a by-product of the burning of fossil fuels (gasoline, LP gas, diesel fuel, etc.). The engines in your tow vehicle and generator (if equipped), furnaces, water heater, LP gas refrigerator and range produce it constantly while they are operating. **CARBON MONOXIDE IS DEADLY.** Please read and understand the following precautions to protect yourself and others from the effects of carbon monoxide poisoning.

Beware of exhaust gas (carbon monoxide) poisoning symptoms:

Dizziness

Vomiting

Nausea

Muscular Twitching

Intense Headache

Throbbing in Temples

Weakness and Sleepiness

Inability to Think Coherently

If you or others experience any of these symptoms, get out into fresh air immediately. If symptoms persist, seek medical attention. Shut down the unit and do not operate until it has been inspected and repaired.

Do not operate an engine with a damaged exhaust system. Check the system frequently for damage. Do not under any circumstances modify the exhaust systems(s) in any way.

CARBON MONOXIDE SAFETY PRECAUTIONS



WARNING

Exhaust gases are deadly. Do not block the tailpipes or exhaust ports, or situate the vehicle in a place where the exhaust gases have any possibility of accumulating either outside, underneath, or inside your vehicle or any nearby vehicles. Outside air movements can carry exhaust gases inside the vehicle through windows or other openings remote from the exhaust outlet. Operate engines, carbon monoxide-producing systems or components only when safe dispersion of exhaust gases can be assured. Monitor outside conditions to be sure that exhaust continues to be dispersed safely.



WARNING

Do not under any circumstances operate any engine while sleeping. You would not be able to monitor outside conditions to assure that engine exhaust does not enter the interior, and you would not be alert to exhaust odors or symptoms of carbon monoxide poisoning.

ON THE ROAD

Your motor home is equipped with a carbon monoxide (CO) detector. It is usually located in the main sleeping area.

If the indicator sounds, it is an indication that carbon monoxide gas is present. This may occur while idling in high traffic concentrations where other vehicles as well as your motor home are contributing to the carbon monoxide level in the surrounding air. Sounding of the alarm does not indicate a faulty alarm. The detector is doing its job of warning you of potentially high concentrations of carbon monoxide. See the section on *Carbon Monoxide* in this manual.

Test the CO detector after the motor home has been in storage, before each trip, and at least once a week during use. Please refer to the operating instructions included in your *Owner's Information Package*.

CARBON MONOXIDE DETECTOR

Consult your *Chassis Operator's Manual* for information on safe and approved towing procedures. Most tow truck operators willing and able to tow motor homes will be familiar with these procedures. Be prepared to give the tow truck operator at least the following information when you call:

Length and height of motor home

Chassis manufacturer

Gross vehicle weight rating

The vehicle must be towed from the front, either on the rear wheels (if operational) or on a heavy duty dolly, or transported on a flat bed trailer. Consult your *Chassis Operator's Manual*.

EMERGENCY TOWING

	CAUTION
<p>Do not tow the motor home from the rear. Towing from the rear will cause serious overloading of the front tires and suspension, possibly resulting in tire or front suspension failure. The rear frame extensions are not designed to withstand the loads imposed by lifting from the rear.</p>	

To prepare your motor home for towing:

1. Secure any loose or protruding parts of the disabled vehicle.
2. Secure any heavy, loose items in the interior.
3. Turn off LP gas appliances and the LP gas tank valve.
4. Do not allow any person to ride in the towed vehicle.

The walls in your motor home are constructed with Vacu-bond® lamination technology. Structural members are located specifically to mount and attach factory installed components and accessories, and may not be located to support after-market accessories not specifically designed for use on or in your motor home.

Please consult with your dealer before attempting to install or mount accessories on the sidewalls of your motor home. Holes drilled in the sidewall may cause damage, and may affect portions of your warranty coverage.

ATTACHING ACCESSORIES TO YOUR MOTOR HOME

Engine temperature gauges have been calibrated to indicate a midrange reading as the “normal” operating temperature. The reason for this is that many owners perceive 212°F as the boiling point. However, this is not the case in an engine with a pressurized cooling system and a coolant mixture of glycol and water. As a motor home owner, be aware that the gauge is intended to provide a warning of any rapid change in engine coolant temperature from the “normal” reading of the gauge rather than an absolute temperature reading.

ENGINE TEMPERATURE GAUGES

This page intentionally blank.

LIVING WITH YOUR MOTOR HOME

Entry steps are located under each entry door. To extend the manual step pull step assembly out; let it down completely. Push step all the way in to store.

MANUAL ENTRY STEPS

 **WARNING**

The distance between the motor home and the ground is too far to easily manage. Be sure the step is out before exiting the motor home.

The power entry step is controlled by the ignition switch and by a switch near the entry door. Power for the entry step is supplied by the coach battery. The battery must be connected for the step to operate as described below. The step has a "last out" feature. With the door closed, the step power switch OFF, turn the ignition switch ON. The step will retract. Turn OFF the ignition, open the door and the step will extend and lock in the OUT position. The switches operate the step according to the following table.

POWER ENTRY STEPS

 **WARNING**

Under certain conditions, the step may not extend using the last-out feature. Always look and be sure the step is extended before exiting the motor home.

Ignition Switch Position	Step Switch Position	Step Position/ Action
OFF	ON	Step extends and retracts with the opening and closing of the door.
OFF	OFF	Step is inactive. Will not move regardless of door movement.
ON	ON	Step extends and retracts with opening and closing of door.
ON	OFF	Step extends and retracts with opening and closing of door. If step is extended when ignition is turned ON, step will retract.

Living With Your Motor Home

An entry assist handle is located outside each entry door.

ENTRY ASSIST HANDLE

The screen door may be separated from the main entry door by depressing the catch or releasing the magnet. A holdback mechanism can be used to secure the main door against the side of the motor home.

ENTRY DOORS AND SCREENS

Windows in your motor home are either slider or torque pane type. Slider windows may be locked by turning the lock knob. Torque windows may be opened and adjusted by turning the knob or crank located at the bottom of the window.

WINDOWS

Any ventilating window may permit water inside. This water must be trapped and provisions made for draining it to the outside.

On your ventilating windows, water is trapped by the frame. During a heavy downpour, water may be seen in the lower portion of the frame. The sloping sill and weep slots allow the water to drain to the outside. These weep slots must be kept open.

If water collects in the bottom channel and overflows, check the weep slots for debris and obstructions.

Living With Your Motor Home

Read and understand these instructions before you need to use them. The emergency exit window provides an emergency means of escape if the motor home doors are blocked or disabled for any reason or in case the motor home must be evacuated under emergency conditions.

EMERGENCY EXIT WINDOW

Turn lock, slide window and/or screen to open and close.

SIDE SLIDER WINDOWS



NOTE

Screens are not removable for cleaning. They may be pushed out of their frames if the window must be used for emergency exit. In this case, the screens will be destroyed and will probably have to be replaced.

The sun visors at the driver's and passenger's positions swing down and adjust to provide relief from glare and bright skies.

SUN VISORS

To raise window shades:

Push up from bottom.

To lower window shades:

Pull straight down on the shade.

Stop the shade in mid-travel by moving it to the desired position.

WINDOW SHADES (SOME MODELS ONLY)

Living With Your Motor Home

To raise mini-blinds:

Push up from bottom.

To lower mini-blinds:

Pull straight down on the blind.

Stop the blind in mid-travel by moving it back to the desired position.

To adjust the angle:

Turn the adjusting rod either direction.

MINI-BLINDS

Exterior storage compartments maximize available space and should accommodate most of your storage needs. All of the storage compartments, except the LP gas compartment, can be locked. Fire-prevention regulations require that the LP gas compartment be unlocked at all times.

STORAGE

EXTERIOR COMPARTMENTS

When storing equipment and supplies:

- » Always keep tools and equipment stored in areas where they will not shift while traveling.
- » Whenever possible, place heavy articles in storage compartments which are low and in the best location for better weight distribution.
- » Pack articles carefully in the storage compartments to minimize shifting. If necessary, use straps to prevent movement.
- » Be sure liquid containers are capped and cannot tip or spill. Secure all glass containers and dishes before traveling.
- » Exterior storage compartments may not be water-tight in all climate conditions. Carry any articles which could be damaged by water inside the motor home.



NOTE

Your motor home could be overloaded or out of balance if not properly loaded. Refer to the **Motor Home Loading** section in this manual, and follow the loading and weighing instructions in that section.



WARNING

Do not store flammable, volatile liquids or hazardous chemicals inside the motor home or in outside storage compartments. Toxic fumes from these liquids or chemicals may enter the interior of the motor home.

Living With Your Motor Home

The closets and cabinets have friction catches or hidden latches along one edge of the door. Overhead doors may have supports to hold them open.

INTERIOR STORAGE

Drawers rest in notches when they are closed. To open drawers, lift up slightly, then pull open.

Closets may be equipped with 12-volt lights that may be switched to turn ON when the closet door is opened. Be sure the light goes OFF when the closet door is closed - your battery will be discharged if it stays ON. If the light stays on when the door is closed, the door switch requires adjustment. The same loading considerations apply to interior storage areas as to exterior. Consult the ***Motor Home Loading*** section in the ***On The Road*** chapter.

The materials used inside your motor home have been selected for durability and comfort. With reasonable care, these materials will stand up under years of recreational living. The ***Maintenance*** chapter in this manual outlines care requirements for the various upholstery fabrics, floor, cabinet, and wall finishes.

INTERIOR AND FURNISHINGS

To convert the dinette into a bed:

1. Unfasten and remove cushions.
2. Reach under the table, fold the legs up under the table top.
3. Raise front portion of table several inches to disengage inserts from the wall supports.
4. Lower table top to the dinette frame to complete bed base.
5. Slide seat and back cushion into place over bed base

DINETTE CONVERSION

Living With Your Motor Home

To convert a sofa/lounge into a bed:

1. Remove sofa bolsters.
2. Lift front of sofa frame up and out.
3. Push the back of the lounge back and down.
4. Push the seat belts through the space between the lounge back and seat.

SOFA/LOUNGE CONVERSION

To restore the sofa/lounge:

1. Pull the seat belts back up through the space.
2. Lift the front edge of the sofa frame up, and push it back.
The sofa back will come up.
3. Push the sofa into position.

The dividers allow you to separate areas in the motor home. They glide on plastic slide tracks and do not require lubrication. They are held closed by a catch. When the dividers are open for traveling, be sure to attach the hold back straps to keep them from sliding back and forth.

FOLDING DOORS/ PRIVACY CURTAIN DIVIDERS

Both decorative and "utility" style 12-volt lighting fixtures may be used in your motor home.

INTERIOR LIGHTING

Utility style fixtures may be either single or dual. A rocker switch selects either single or dual brightness. For your convenience, some lights are operated from wall switches. Clean the lenses in soapy water.

Overhead vents are located in the galley (some models) and bathroom areas for fresh air circulation and exhausting heat, odors, and water vapor.

OVERHEAD VENTS

Turn the crank in the center of the vent to open and adjust. Some vents may also be equipped with a 12-volt fan. A switch controls fan operation. Be sure to turn the fan OFF before closing the vent.

Close the vents or lower them before traveling to avoid damage from wind and low overhead clearances.

The vents may be cleaned from the top of the motor home. Use soapy water on the vent cover. The screens may be vacuumed or lightly brushed to remove accumulation of leaves or other debris.

Lubricate the gears and mechanism yearly with a light, water resistant grease.

The monitor panel allows you to conveniently check the approximate levels in tanks and to check battery condition(s).

MONITOR PANEL

Electrical probes installed in the tanks measure the levels at various points in the tanks.

To check tank levels:

Press LP GAS, WATER or HOLDING TANK 1 or 2 rocker switches. HOLDING TANK 1 is the black water (toilet waste) tank, and HOLDING TANK 2 is gray water (sink and shower wastes).

The E or empty indicator light will always be lit when the rocker switches are depressed. If the tank is full, all lights will be on. Lights are sequential, and indicate the level in approximately $\frac{1}{4}$ tank increments. If the tank selected is approximately $\frac{1}{2}$ -full, for example, lights E, $\frac{1}{4}$ and $\frac{1}{2}$ will be on.

LIVING WITH YOUR MOTOR HOME

Erroneous tank level indications can be caused by:

- a. Water with low mineral content. The level is measured by a very low level electrical signal traveling through the liquid. Some water may not conduct the signal properly. This condition may be infrequent, but can exist. Check the panel reading when the fresh water tank is filled.
- b. Material trapped on the sides of the holding tanks may give a full reading when the tank is actually empty.

To check the battery charge:

1. Unplug the 120-volt AC power cord to turn the power converter off.
2. Press BATTERY rocker switch on the panel.
3. Turn on a light or any 12-volt appliance. The battery must be checked with a load.
4. Read battery condition on the meter. Red is low, yellow is fair and green is good.



NOTE

If the sensor probes mounted in the tanks get coated with grease, the monitor panel may indicate falsely or not at all. Avoid pouring grease, oils or similar substances down drains or the toilet. If this is unavoidable, the holding tank(s) should be washed out with a soapy water solution. See your dealer for additional information.

Your motor home was designed primarily for recreational use and short term occupancy. If you intend to occupy the motor home for an extended period, you should understand that the additional wear will cause premature deterioration of structure, interior finishes, fabrics, carpeting, drapes, appliances and fixtures. You should also be prepared to deal with condensation and the humid conditions that may be encountered. The relatively small volume, and tight, compact construction of modern recreational vehicles mean that normal living activities of even a few occupants will lead to rapid saturation of the air, and the appearance of visible moisture, especially in cold weather.

Just as moisture collects on the outside of a glass of cold water during humid weather, moisture can condense on the inside surfaces of your motor home during use in cold weather when humidity of the interior air is high.

EFFECTS OF LONG TERM OCCUPANCY

LIVING WITH YOUR MOTOR HOME

Water vapor will condense on the inside of the windows and walls as moisture, or in cold weather as frost or ice. It may also condense out of sight within the walls or the ceiling where it will manifest itself as stained panels. Appearance of these conditions indicates a condensation problem. When you recognize the signs of excessive moisture and condensation, you should take action to minimize their effects.

You can reduce or eliminate interior condensation during cold weather by taking the following steps:

» ***Ventilate with Outside Air***

Partially open one or more roof vents and one or more windows to provide controlled circulation of outside air into the interior. While this ventilation will increase furnace heating load, it will greatly reduce, or eliminate, condensation. Even when it is raining or snowing, outside air will be far drier than interior air and will effectively reduce condensation.

» ***Install Aftermarket Storm Windows***

The interior surface of the storm window will be warmer, reducing moisture condensation. **Do not cover the emergency exit window.** This window must be left accessible at all times for emergency exit.

» ***Reduce Moisture Released Inside the Motor Home***

Run the range vent fan when cooking and the bath vent fan (or open the vent) when bathing to carry water vapor out of the motor home. Avoid making steam from excessive boiling or use of hot water. Remove water or snow from shoes before entering to avoid soaking the carpet. Avoid drying overcoats or other clothes inside the motor home.

VENTILATION AND CONTROLLING CONDENSATION

	CAUTION
Do not heat the motor home interior with the range or oven.	
Open flames add moisture to the interior air. Do not use an air humidifier inside the motor home. Water put into the air by the humidifier will increase condensation.	

Living With Your Motor Home

» *Ventilate Closets and Cabinets*

During prolonged use in very cold weather, leave cabinet and closet doors partially open to warm and ventilate the interiors of storage compartments built against exterior walls. The air flow will warm the exterior wall surface, reducing or eliminating condensation and preventing possible ice formation.

» *Install a Dehumidifier Appliance*

During prolonged, continuous use, a dehumidifying appliance may be more comfortable and effective in removing excess moisture from the interior air. While use of a dehumidifier is not a "cure-all," and ventilation, storm windows, and moisture reduction continue to be important, operation of the dehumidifier will reduce the amount of outside air needed for ventilation. Heating load on the furnace will be reduced, and the interior will be less drafty.

The hazard and possibility of fire exists in all areas of life, and the recreational life-style is no exception. Your motor home is a complex machine made up of many materials - some of them flammable. But like most hazards, the possibility of fire can be minimized, if not totally eliminated, by recognizing the danger and practicing common sense, safety and maintenance habits.

FIRE SAFETY

The fire extinguisher furnished with your motor home is rated for Class B (gasoline, grease, flammable liquids) and Class C (electrical) fires since these are the most common types of fires in vehicles. Read the instructions on the fire extinguisher. Know where it is located and how and when to use it.

Living With Your Motor Home

Remember that portable fire extinguishers are appliances intended for use only by the occupants of a building or area that is threatened by fire. They are most valuable when used immediately on small fires. They have a limited amount of fire-extinguishing material, and therefore must be used properly so this material is not wasted.

Fire extinguishers are pressurized, mechanical devices. They must be maintained as outlined and any maintenance instructions provided with the device so they are ready to operate properly and safely. Parts or internal chemicals may deteriorate in time and need replacement. Always follow maintenance and recharging instructions provided by the fire extinguisher manufacturer.

Explosive fuel clouds may be present at fuel filling stations.

Instruct occupants on what to do in case of fire, and hold fire drills periodically.

Maintain proper charge in the fire extinguisher.

If you experience a fire while traveling, ***Maintain control of the vehicle until you can safely stop. Evacuate the vehicle as quickly and safely as possible.***

If you experience a fire while camped, ***Evacuate the vehicle as quickly and safely as possible.***

Consider the cause and severity of the fire and the risk involved before trying to put it out. If the fire is major or is fuel-fed, move away from the side of the LP gas tank, stand clear of the vehicle and wait for the fire department or other emergency assistance.

If your motor home is damaged by fire, do not drive or live in it until you have had it thoroughly examined and repaired.

FIRE SAFETY PRECAUTIONS



WARNING

Before refueling (either gasoline, diesel, or LPG) be sure to turn off all pilot flames and appliances in your motor home. Turning off the propane at the tank is insufficient. Pilotless appliances may still spark or pilot flames may not extinguish immediately.



WARNING

Do not store or carry LP gas containers, or other flammable liquids inside your motor home.

Living With Your Motor Home

A battery-powered smoke detector is mounted on the ceiling or wall in the living/cooking area of your motor home. Please read the smoke detector operating instructions for details on testing and caring for this important safety device.

Test the smoke detector after the motor home has been in storage, before each trip, and at least once a week during use.

The smoke detector should never be disabled due to nuisance or false alarm from cooking smoke, a dusty furnace, etc. Ventilate your motor home with fresh air and the alarm will shut off. ***Do not disconnect the battery.***

Replace the battery once a year or immediately when the low battery BEEP signal sounds.

If the smoke detector fails to operate with new batteries, replace it with a new unit, available through an authorized Fleetwood Service Center.

SMOKE DETECTOR



WARNING

Urethane foam is flammable!

Do not expose urethane foams to open flames or any other direct or indirect high temperature sources of ignition such as burning operations, welding, burning cigarettes, space heaters or unprotected electric light bulbs.

Once ignited, urethane foams will burn rapidly, releasing great heat and consuming oxygen at a high rate. In an enclosed space the resulting deficiency of oxygen will present a danger of suffocation to the occupants. Hazardous gases released by the burning foam can be incapacitating or fatal to human beings if inhaled in sufficient quantities.

PLUMBING SYSTEMS

The plumbing systems in your motor home are constructed of thermoplastic materials. Holding tanks and piping components are strong, lightweight, and corrosion resistant.

Fresh water is available from either an external "city water" hookup or on-board storage.

The external system is pressurized by the water system at an RV park or city water supply.

FRESH WATER SYSTEM

CAUTION

Since water pressures at campgrounds vary, we recommend you install an in-line pressure regulator at the water supply faucet. This will protect the motor home water system and your supply hose from excessively high water pressure.

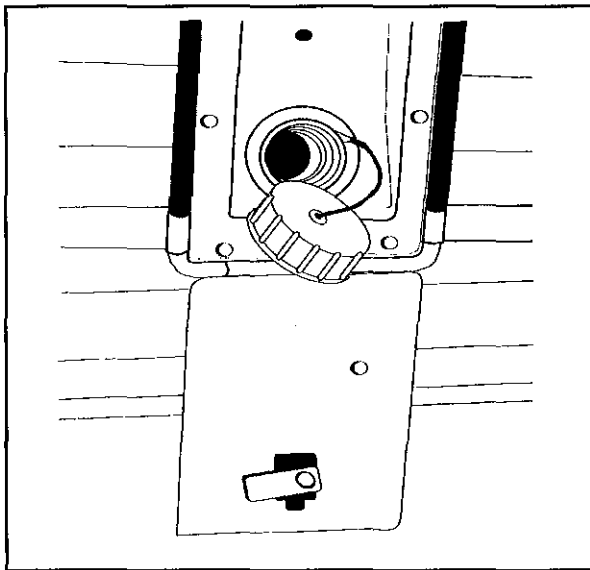

Filling the Water Tank

Plumbing Systems

Connect the city water system as follows:

1. Connect one end of a potable water hose to park or city water supply. This will usually be a faucet or valve similar to your garden hose valve at home. "Potable water" hoses are available at RV supply stores.
2. Run the city water supply for a few seconds to clear the line.
3. Turn OFF the supply.
4. Connect the hose to the inlet fitting.
5. Turn ON the supply. Open all faucets and clear the lines. Close faucets.

Disconnect the city water as follows:

1. Close the park or city water supply valve.
2. Remove the hose from the city water supply valve.
3. Disconnect the hose from the inlet, coil and store it.

CITY WATER CONNECTION

	CAUTION
Overfilling the fresh water tank from a pressurized source will cause serious damage to the water tank or structural components. Monitor water tank filling continually.	

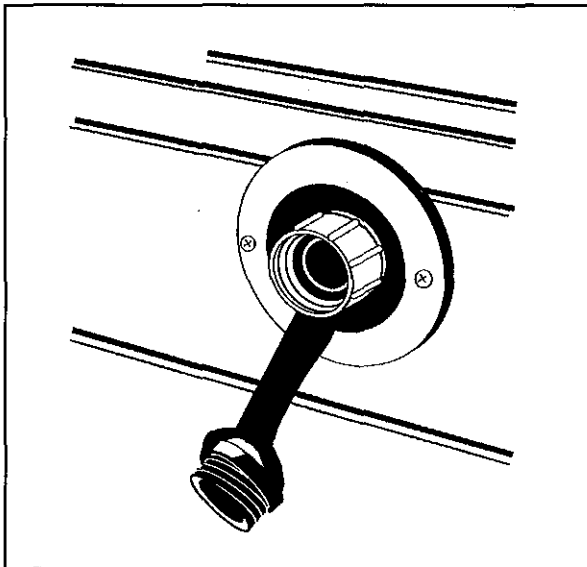

City Water Connection

The on-board water storage tank may be filled through a special filler cap outside the motor home. To fill the fresh water tank, open the spout, and fill the tank using a potable water hose. Check the monitor panel often to determine when the tank is full. If water is flowing from the top vent, your tank is overfilled. Stop filling. After filling the tank, replace vent plug and filler cap.

Avoid leaving water in the tank when the motor home is not in use. Turn the water pump ON while draining the water tank. Whenever possible, drain the fresh water tank before traveling. Water in the tank will reduce the carrying capacity of the motor home. See *Motor Home Loading* section of the *On The Road* chapter.

The on-board fresh water system is pressurized by a self-priming, 12-volt DC pump. The pump operates automatically when the pump power switch is ON and a faucet is opened. When the faucets are closed, the pump shuts off. At free flow, the pump draws approximately 7 to 7½ amps, and can run dry for extended periods without damage. A 15-amp fuse at the converter panel protects the pump circuit. See *Electrical Systems* chapter.

THE WATER PUMP

Turn the pump master switch ON to pressurize the system. When a faucet is opened after the initial filling of the tank, the water may sputter for a few seconds. This is normal and is not cause for concern. The water flow will become steady when all air is bled from the water lines.

Plumbing Systems

Dirt, mineral scale, and organic matter are filtered out of the fresh water system by an in-line water filter on the inlet side of the water pump. If you suspect a clogged filter, it is easily removed and cleaned.

WATER FILTER

Inspect the filter after the first 90 days of use, clean if necessary, and inspect annually thereafter.

1. Turn water pump switch OFF and unscrew the water line fitting from the filter.
2. Unscrew the filter from the water pump.
3. Turn each end of the filter and pull apart.
4. Flush out and clean screen.
5. Reverse procedure to install.
6. Operate the water pump and check for leaks.

Water system problems usually fall into two categories: inherent system problems, and problems caused by neglect. System problems are usually the result of road vibration and campsite water pressure variations. Problems of neglect usually stem from failure to clean filters, improper winterization, and poor battery maintenance. Most water system problems can be avoided by conscientious maintenance.

TROUBLESHOOTING THE FRESH WATER SYSTEM

Vibration, flexing and twisting while traveling can work pipe fittings loose. Check all plumbing for leaks at least once a year. If the water pump runs when a faucet is not open, suspect a leak. Be sure the tank drain valves are tightly closed. Leaks occur most often around threaded fittings. If necessary, tighten or clean and tighten the fittings. Do not over-tighten fittings. Connections at galley and lavy fixtures should not be tightened with a wrench. They will normally seal with hand-tightening. If a leak persists at one of the fittings, disconnect it completely and check for mineral deposits or other foreign matter at the seating surfaces. Clean the surfaces thoroughly and reinstall the fitting.

LEAKS

Connections at the water tank, pump and valves are made with special clamps. They can be replaced with standard aircraft type hose clamps.

Leaks caused by freezing damage can be prevented by proper winterization of the system. See *Storage* chapter of this manual. Freezing damage is usually extensive and may include a burst water tank, split piping, and a damaged water pump, toilet, and water heater. If you experience this type of damage, repairs can best be made by an authorized Fleetwood dealer.

Sanitize the fresh water tank and piping approximately every three months, and whenever the motor home sits for a prolonged period. This will discourage the growth of bacteria and other organisms that can contaminate the water supply. Use a chlorine/fresh water rinse as follows:

SANITIZING THE FRESH WATER SYSTEM

1. Prepare a solution of ¼-cup household liquid chlorine bleach (5% sodium hypochlorite) to one gallon of water for each 15 gallons of tank capacity.
2. Close drain valves and faucets, pour chlorine solution into the fresh water tank filler spout, and complete filling with fresh water.
3. Turn water pump switch ON. (Be sure you have 12-volt DC power.) Open all faucets individually until water flows steadily, then turn off. This will purge any air from the lines.
4. Top off water tank with fresh water and wait three hours.
5. Drain the entire system by opening all fresh water tank valves, faucets, and plumbing line drain valves.
6. Flush the system with drinking quality water. Let the fresh water flow through the system for several minutes to flush out the chlorine solution.
7. After you stop the flushing, close the tank valve, faucets, and drain valves. You can now fill the tank with fresh water, and the system is ready to use.

Plumbing SYSTEMS

A shower fixture is located in an exterior compartment on selected models. The water pump must be ON or city water pressure must be available for the shower to operate.

Please note that the special faucet at the galley is the only outlet for the purified water. Although purified water is not available at the standard galley and lavy outlets, the water available at these outlets is filtered by the water pump filter. Note also that this system is not designed for or effective in removing or neutralizing bacterial contaminants.

**EXTERIOR
SHOWER
(SOME MODELS
ONLY)**

The waste water system in your motor home is made up of sinks, tub, shower, toilet, plumbing drain and vent lines, a *grey water* holding tank, and a *black water* holding tank. Generally, water from the sinks and shower drains into the grey water tank; the toilet drains into the black water tank. The holding tanks make the system completely self-contained and allow you to dispose of waste water at your convenience. A flexible sewer hose is required to connect the holding tank outlet to the inlet of an approved waste water dump station or sewer system.

**WASTE WATER
SYSTEM**

The drain plumbing is similar to that used in your home. The system is trapped and vented to prevent waste gases from backing up into the motor home. The drain plumbing is made of ABS plastic, and is durable and resistant to most chemicals.

Your motor home is equipped with a marine-type toilet. Please follow the operating instructions found in your *Owner's Information Package*.

TOILET

DRAINING THE HOLDING TANKS

 **WARNING**

Holding tanks are enclosed sewer systems and as such must be drained into an approved dump station. Both black and grey water holding tanks must be drained and thoroughly rinsed regularly to prevent accumulation of harmful or toxic materials.

 **NOTE**

Local or state regulations may prohibit highway travel unless the holding tank outlet is securely capped.

The holding tanks terminate in a valve arrangement that permits draining each tank separately or together. The valves are called “knife valves.” A blade closes the opening in the sewer drain pipes. The blade is connected to a T-handle that is pulled to release the contents of the tank(s). During self-containment use, the sewer line is securely capped to prevent leakage of waste material onto the ground or pavement. ***Do not pull the holding tank knife valve open when the protective cap is installed on the pipe.*** Always drain the tank into an acceptable sewer inlet or dump station.

Whenever possible, drain the holding tanks before traveling. Waste water and sewage in the holding tanks reduce the carrying capacity of the motor home. See ***Motor Home Loading*** section of the ***Living With Your Motor Home*** chapter.

Drain the holding tanks only when they are at least $\frac{3}{4}$ full. If necessary, fill the tanks with water to $\frac{3}{4}$ full. This provides sufficient water to allow complete flushing of waste material into the sewer line.

During extended or semi-permanent hookups to sewage systems, waste materials will build up in the tank and cause serious plugging if the tank valves are continuously open. In these cases, keep the valves closed until the tanks are $\frac{3}{4}$ full, and then drain into the sewage system.

The holding tank drain valve outlet is to be used with a removable termination fitting that locks onto the outlet with a clockwise twist. Clamp the sewer drain hose to this fitting. A protective cap should remain in place when you are not draining the tanks.

PLUMBING SYSTEMS

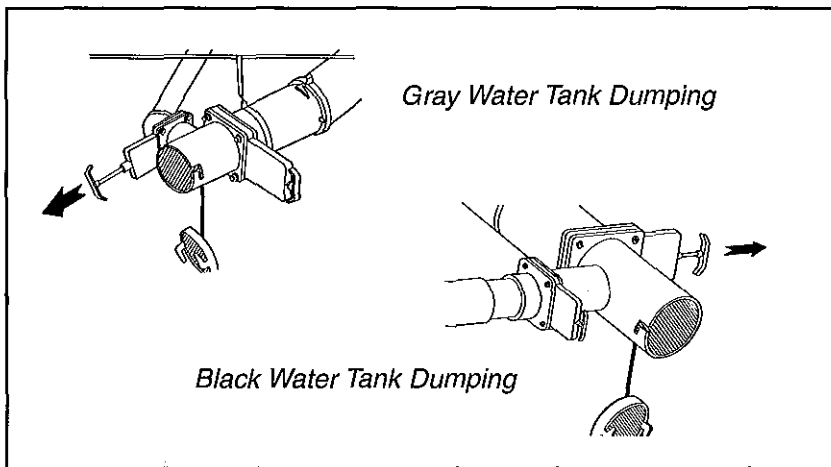

To drain the holding tanks:

1. Attach the sewer hose to the holding tank outlet. Insert the end of the hose into the sewer or dump station inlet, pushing it firmly far enough into the opening to be secure. In some cases, adapters may be necessary between the line and the inlet. Arrange the sewer hose so it slopes evenly.
2. Drain the black water holding tank first. Grasp the handle of the black water knife valve (the large one) firmly and slide the valve open with a quick, steady pull.
3. Allow enough time for the tank to drain completely. Rinse and flush the tank through the toilet. When the tank is empty, push the handle in to close the valve. Run enough water into the tank to cover the bottom. This will aid the break up of solid wastes.
4. To drain the grey water tank, repeat the steps above using the small knife valve. This tank is drained last to aid in flushing the outlets and hose. The grey water knife valve may be left open in a semi-permanent hookup.
5. Remove the sewer hose and cap the outlet.
6. Rinse out the sewer hose with fresh water and remove the sewer hose from the dump station.
7. Replace sewer or dump station covers.

Please...Practice good housekeeping when draining wastes at a campsite or disposal station. Leave the site in good order. Above all, do not pollute.

HOLDING TANK CARE

Since holding tanks don't rely on any sophisticated mechanical devices for their operation, they are virtually trouble free. The most common problem is also an unpleasant one — clogging. You can minimize the chances of clogging by keeping the following considerations in mind:

- » Keep the black water tank knife valve closed. Fill tank to at least $\frac{3}{4}$ full before draining. Be sure to cover the tank bottom with water after draining.
- » Use only toilet tissue formulated for use in septic tank or RV sanitation systems.
- » Keep both knife valves closed and locked, and the drain cap tightly in place when using the system on the road.
- » Use only cleaners that are approved for use in septic tank or RV sanitation systems.
- » Use a special holding tank deodorant chemical approved for septic tank systems in the black water holding tank. These chemicals aid the breakdown of solid wastes and make the system much more pleasant to use.
- » Do not put facial tissue, paper, ethylene glycol-based or other automotive antifreeze, sanitary napkins or household toilet cleaners in the holding tanks.
- » Do not put anything solid in either tank that could scratch or puncture the tank.

Plumbing SYSTEMS

If the drain system does get clogged:

- » Use a hand-operated probe to loosen stubborn accumulations. Seriously clogged P-traps may require disassembly. Be careful not to overtighten when reassembling.
- » Do not use harsh household drain cleaners.
- » Do not use motorized drain augers.
- » Sometimes the holding tank valve will get clogged. In this case, a hand-operated auger may be necessary. Be ready to close the valve quickly once the clog is cleared. If the seal gets damaged, it is easily replaced.

ELECTRICAL SYSTEMS

The electrical systems in your motor home are designed and built in accordance with all regulations, codes, and standards in effect at the time the motor home was built.

This is the vehicle electrical system. It includes the vehicle battery, charging system, ignition system, instrument panel and controls, and the headlights, taillights, turn signals, and other vehicle lights and accessories.

CHASSIS ELECTRICAL SYSTEM

Replace bulbs with equivalent types as marked on the bulb.

Fuses for the chassis electrical system are located under the instrument panel on the left. Additional fuses may be located under the hood. Others may be found in the 12-volt power leads on the related equipment and accessories.

CHASSIS BULBS AND FUSES

All 12-volt lighting fixtures, convenience outlets, 12-volt powered vents, fresh water pump, and 12-volt accessories are included in this system.

The 12-volt power is provided by special deep-cycle, high capacity coach storage battery/ies. Power is also provided by an AC/DC power converter for use when the motor home is plugged into a 120-volt power source. Battery charge is maintained by the motor home engine alternator, or by the converter.

12-VOLT COACH SYSTEM



NOTE

All living area radios and tape decks draw from the chassis or coach battery, and extended usage when not traveling may discharge them.

ELECTRICAL SYSTEMS

AUXILIARY START SYSTEM

The **Auxiliary Start System** permits using the coach battery to start the motor home engine if the chassis battery is discharged.

To use the Auxiliary Start System:

1. Be sure the vehicle is stopped, shift to "P" (PARK) and apply the parking brake.
2. Press and hold the **Auxiliary Start** switch on the instrument panel.
3. Start engine with ignition switch.
4. Release **Auxiliary Start** switch.

The **Auxiliary Start System** has no effect on the vehicle except to aid in starting the motor home engine. If the vehicle alternator is operating properly, the batteries will be recharged while driving.

Check the external condition of the battery periodically. Look for cracks in the cover and case. Check the vent plugs and replace if they are cracked or broken. Keep the battery clean. Accumulations of acid film and dirt may permit current to flow between the terminals and discharge the battery.

BATTERY INSPECTION AND CARE

To clean the battery:

1. Wash it with a diluted solution of baking soda and water to neutralize any acid present.
2. Then flush with clean water. Foaming around terminals or on top of the battery is normal acid neutralization. Avoid getting the soda solution in the battery. Be sure the vent caps are tight.
3. Dry the cables and terminals.
4. Don't use grease on the bare metal inside the cable terminals to prevent corrosion. Grease is an insulator. Electricity will not flow through it. A plastic ignition spray will protect the terminals after you have cleaned and reinstalled them.

	WARNING
Disconnect the 120-volt electric cord and the negative terminal from the coach battery/ies before working on either electrical system.	

5. Check the battery often. Keep the carrier and hold down hardware clean and free of corrosion and chemical accumulation.

 **WARNING**

Do not allow battery electrolyte to contact skin, eyes, fabrics, or painted surfaces. The electrolyte is a sulfuric acid solution which could cause serious personal injury or property damage. Wear eye protection when working with batteries.

 **WARNING**

Remove rings, metal watchbands, and other metal jewelry before working around a battery. Use caution when using metal tools. If a tool contacts a battery terminal or metal connected to it, a short circuit could occur which could cause personal injury or fire.

Both sets of batteries will be kept charged by the chassis charging system while on the road. The AC/DC power converter will charge the coach battery when plugged into 120-volt service. On those occasions when the battery needs to be charged from a different charging source, please follow these guidelines:

BATTERY CHARGING

 **WARNING**

Never expose the battery to open flame or electric spark. Chemical action in the battery generates hydrogen gas which is flammable and explosive. Do not allow battery electrolyte to contact skin, eyes, fabrics, or painted surfaces.

- »» Leaving a charger connected to a battery for an extended period of time can shorten battery life.
- »» Do not smoke near batteries being charged or which have been recently charged. Please note that batteries are being charged while you drive, and while you are connected to 120-volt power through the converter/charger circuit.
- »» Do not break live circuits at the terminals of the battery. Use care when connecting or disconnecting booster leads or cables. These actions, and poor connections, are a common cause of electrical arcs which can cause an explosion.
- »» Check and adjust the electrolyte level before charging. Fill each cell to the indicator with distilled water.
- »» Always remove vent caps before charging the battery.
- »» Do not charge the battery at a rate that causes the electrolyte to spew out.

ELECTRICAL SYSTEMS

When the battery requires replacement, always choose a battery with the same physical and electrical characteristics as the original equipment. Your dealer or an authorized Fleetwood Service Center can advise you on proper battery selection.

SELECTING A REPLACEMENT BATTERY

This system provides grounded electrical service for appliances such as air conditioners, TV, microwave ovens, etc. The 120-volt system also provides a power source for the converter.

120-VOLT SYSTEM

Your motor home is equipped with a heavy duty power cord to connect to an external 120-volt, 30 amp AC service. The cord and connector are molded together to form a weatherproof cable assembly. Do not cut or alter the cable in any way. Do not remove the ground pin in the cable connector, or defeat the ground circuit in the motor home.

	WARNING
Do not operate the 120-volt electrical system without a proper ground. Electrocutation or severe electric shock could result.	

The converter will automatically supply 12-volt power when your motor home is operating on 120-volt power from the generator or a public utility. It will also charge the coach battery.

POWER CONVERTER

Bathroom, galley and patio 120-volt electrical outlets are protected by a **Ground Fault Circuit Interrupter (GFCI)**. This device is intended to protect you against the hazards of electrical shocks possible when using electrical appliances in the bathroom or galley or in damp areas. Should a circuit or appliance (electric shaver, hair dryer, etc.) develop a potential shock hazard, the GFCI device is designed to disconnect the outlet (and other outlets on the same circuit), limiting your exposure time.

GROUND FAULT CIRCUIT INTERRUPTER (GFCI)

	NOTE
If an outlet doesn't work, check the GFCI. Reset it if necessary. If the GFCI continues to trip, have the motor home electrical system checked at an authorized Fleetwood Service Center or by a qualified electrician.	

Test the GFCI at least once a month. To test the GFCI:

1. Connect to 120-volt AC.
2. Push the **TEST** button. The **RESET** button should pop out, indicating that the protected circuit has been disconnected.
3. To restore power push the **RESET** button.

Your *Owner's Information Package* contains a card that can be used to record test dates. Keep the card in a conspicuous place, and keep it up to date.

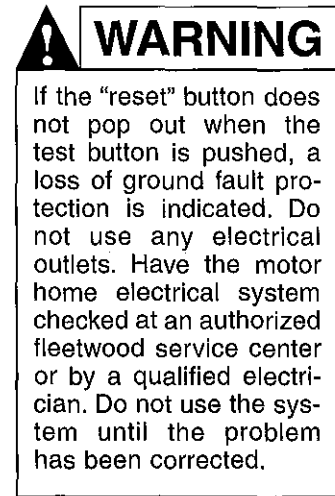
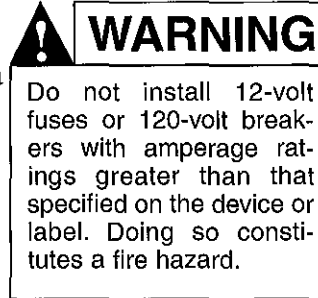

The 120-volt circuit breakers and 12-volt fuses are located in the same compartment. These devices interrupt the power if the circuit is overloaded.

The 120-volt circuit breakers include a 30 amp main breaker and several smaller breakers for individual circuits. If a circuit breaker is tripped, look for an overload on that circuit, then reset it by turning the breaker OFF and then turning it ON. Do not try to reset a breaker the second time without locating the overload problem.

The 12-volt fuses protect individual circuits. If the circuit is overloaded, it will blow the fuse and the fuse must be replaced. Check the circuit for an overload and replace the fuse with the same type and amperage rating.

COACH FUSES AND CIRCUIT BREAKERS

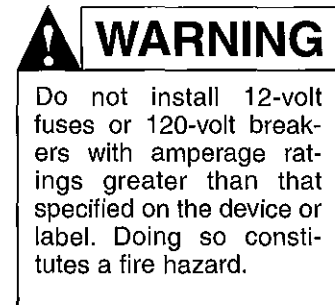

ELECTRICAL SYSTEMS

Your motor home may be equipped with a gasoline-powered generator which will provide complete electrical self-containment when regular public utility AC power is unavailable. Controls are at the generator and at a remote control panel located inside the motor home.

With the generator operating, and the power cord plugged into the receptacle, power is available at all of the 120-volt power outlets in the motor home, just as if the cord were connected to an external source. The generator is also connected to the power converter, thus supplying 12-volt power as well.

GENERATOR

Gasoline for the generator is taken from the main fuel tank through a special feeder tube which is higher in the tank than the feeder tube to the motor home. This arrangement prevents the generator from running the motor home fuel tank dry.

GENERATOR FUEL SUPPLY

To start the generator:

1. Hold the switch in the START position until the unit starts.
2. Then release the switch. If the unit is slow to start, DO NOT hold the switch in the START position for more than 10 seconds.
3. Release the switch, wait 15 seconds, then repeat. This will help avoid overheating and damage to the generator starting system.

To stop the unit:

Hold the switch to the STOP position until the engine stops. If you release the switch too soon, the engine will continue to run.

GENERATOR OPERATION



NOTE

*Refer to the generator operating instruction manual provided in your **Owner's Information Package** for information before starting the generator. Do not start the generator unit with a heavy power load. Always wait at least three minutes after starting generator before turning on (or plugging in) heavy electrical loads, such as the roof air conditioner.*

ELECTRICAL SYSTEMS

Read and understand the generator operating, maintenance and safety instructions furnished in your *Owner's Information Package*.

- » Do not smoke or use an open flame near the generator unit or fuel tank.
- » Do not use generator ventilating air for heating any interior living space. Ventilating air can contain high concentrations of lethal gases.
- » Check engine fuel lines often. Fuel leakage in or around the compartment is an extreme fire hazard. Do not use the generator until fuel leaks are repaired.
- » Be aware of exhaust gas (carbon monoxide) poisoning symptoms. Refer to section on *Carbon Monoxide Safety Precautions* in the *On The Road* chapter.

GENERATOR OPERATING SAFETY PRECAUTIONS

 **WARNING**

Do not under any circumstances operate the generator while sleeping. You would not be able to monitor outside conditions to assure that generator exhaust does not enter the interior, and you would not be alert to exhaust odors or symptoms of carbon monoxide poisoning.

 **WARNING**

Do not block the generator ventilating air inlets or outlets. The engine requires a constant supply of cooling air. Restricted ventilating air inlets or outlets can cause engine failure or fire from engine overheating.

 **WARNING**

Do not place flammable material or store any other materials in the generator compartment.

 **WARNING**

Exhaust gases are deadly. Inspect the generator exhaust system thoroughly before starting the generator engine. Do not block the tail pipe or situate the motor home in a place where the exhaust gases have any possibility of accumulating either outside, underneath, or inside your vehicle or any nearby vehicles. Outside air movements can carry exhaust gases inside the vehicle through windows or other openings remote from the generator exhaust. Operate the generator only when safe dispersion of exhaust gases can be assured, and monitor outside conditions to be sure that exhaust gases continue to be dispersed safely.

ELECTRICAL SYSTEMS

- » Check the generator exhaust system after every 8 hours of operation and whenever the system may have been damaged, and repair any leaks or obstructions before further operation. Disconnect the battery before performing any maintenance on the generator. Allow the generator to cool sufficiently before performing any maintenance.

	WARNING
<p>Do not operate the generator when parked in or near high grass or brush. Exhaust heat may cause a fire.</p> <p>Do not modify the generator installation or exhaust system in any way.</p> <p>Do not use the generator as an emergency power source to a general residential or industrial utility line. This is illegal and may result in shock or electrocution to power line utility personnel attempting repairs to the power lines.</p>	

Because of the many model, floor plan and option variations available, it is beyond the scope of this manual to include all wiring diagrams possible. In certain situations, specific wiring diagrams may be available to help troubleshoot a problem. If you need specific wiring information, please contact your dealer. Complete wiring diagrams are not available.

ELECTRICAL SYSTEM WIRING

LP GAS SYSTEM

Liquefied petroleum (LP) gas is available from approved storage tanks to operate your range, oven, furnace and water heater, and as an alternate energy source for some refrigerators. With proper handling precautions, LP gas is safe and provides modern conveniences wherever you travel. LP gas is stored as a liquid under pressure and vaporizes under the control of a pressure regulator.

A typical LP gas tank installation is illustrated below. Although specific details of the system may differ in your motor home, the major components and their relationships will be similar to those shown.

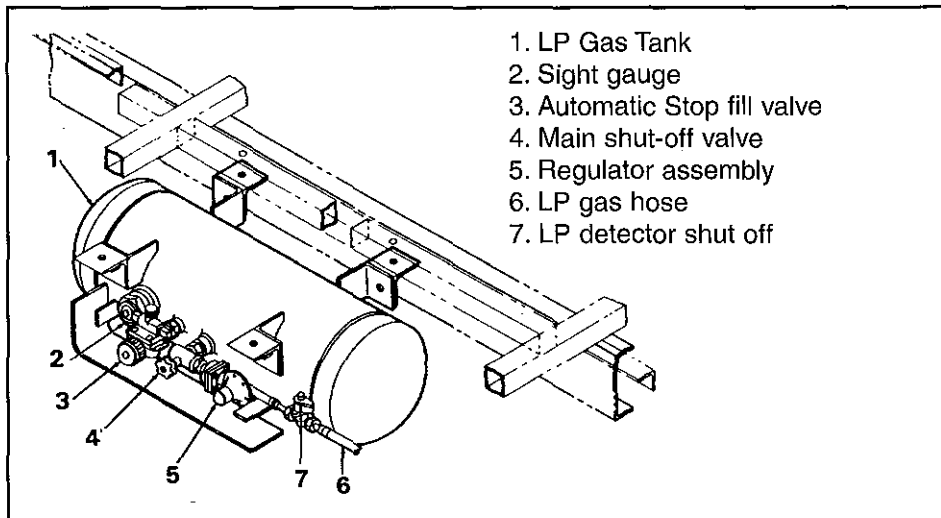

LP GAS SYSTEM

LP gas is a safe and reliable fuel. As with any other volatile and flammable material, common sense dictates that LP gas be handled and used with respect and caution. Because LP gas systems are so reliable, they are often taken for granted. Neglect can be a very dangerous habit. If the system is maintained regularly, you can expect almost trouble-free operation.

LP GAS SAFETY PRECAUTIONS

WARNING

LP gas is flammable and potentially explosive. Use proper handling, lighting and ventilating procedures.

1. The distinctive odor of LP gas indicates a leak. If you smell gas:

Do not touch electrical switches.

Extinguish all open flames, pilot lights and all smoking materials.

Shut off the gas supply at the tank valve(s) or gas supply connection.

Open the door and leave the area until the odor clears.

Have the gas system checked by a professional and the cause of the leak corrected before using the motor home again.

2. Inspect the entire LP gas system for leaks or damaged parts before each trip and before filling tank. See section on "LP Gas System Leak Checks."

3. Never check for leaks with an open flame. Use an approved leak detection solution or a non-ammoniated, non-chlorinated soap solution only. If the leak cannot be located, take the unit to an LP gas service representative.

4. Always be careful when drilling holes or fastening objects to the motor home. The gas supply lines could be punctured by a nail or screw.

5. Do not restrict access to LP tanks. In an emergency, the tank service valve must be easily identified and accessible. The tank compartment door must always be unlocked, and the LP label should be visible.

WARNING

6. Do not carry or store filled or empty LP gas containers, including accessories such as gas barbecues, in your motor home. LP gas containers are equipped with a safety device that relieves excessive pressure by discharging gas to the atmosphere. Leaks can occur at valves and fittings. Always store LP tanks outside with the valves closed and plugged.

7. Do not use any LP gas tank other than the one furnished with your motor home without being sure that all connecting components are compatible.

8. Turn off LP gas main valve before filling LP gas tank or entering an LP gas bulk plant or motor fuel service station. Turn off all pilot lights and appliances individually before refueling of motor fuel tanks and/or LP gas containers. When not individually turned off, automatic ignition appliances may continue to spark when LP gas is turned off at the container.

9. Do not fill LP gas containers to more than 80% capacity. Overfilling can result in uncontrolled gas flow which can cause fire and explosion. A properly filled container holds about 80% of its volume as liquid.

10. LP gas regulators must always be installed with the diaphragm vent facing downward. Make sure that the regulator vent faces downward and that the cover is kept in place to minimize vent blockage which could result in excessive gas pressure causing fire or explosion.

11. Do not use a wrench or pliers to close the tank shut-off valve. This valve is designed to be closed leak-tight by hand. If a tool is required to stop a leak, the valve probably needs repair or replacement.

12. If you do not have the special tools and training necessary, do not attempt to repair or modify LP gas system components.

13. Always think safety.

LP GAS SYSTEM

The hoses used in your LP gas system meet *UL* or *CSA* requirements, and are rated to withstand many times the pressures encountered in the system. Although they are designed for efficient and trouble free use, they can deteriorate from impurities in the air. The average life of LP hoses is two to three years. Consequently, check the hoses for weather checking or other signs of deterioration every time you have the gas tank filled or serviced. When you replace hoses, be sure that replacements are properly rated and approved for RV use.

SYSTEM COMPONENTS

HOSES

The regulator is the heart of the LP gas system. It reduces the tank pressure, which can vary from 250 psi to 7 psi, to a steady 6 ounces (11 inches of water column) to serve the appliances in the motor home. It does this in two stages for safety and efficiency.

LP GAS REGULATOR

Because the regulator is constantly “breathing,” it is equipped with a vent. It is very important that the vent stays clean and free from obstruction. Clogging from corrosion, dirt, insect nests or other debris is the most common cause of regulator malfunction. Even a small piece of material that finds its way into the vent can result in improper pressure in the system and possible damage to or failure of components. The regulator is mounted so that the vent is facing downward and is protected from water and dirt by a water-resistant cover. Be sure the cover is on at all times. If the vent becomes clogged, it can be cleaned with a toothbrush. If corrosion is evident, contact a qualified LP gas service technician for a replacement regulator.

	WARNING
Do not attempt to adjust the regulator. It has been preset by the regulator manufacturer. If any adjustment is required, it must be made by a qualified LP gas service technician using special equipment.	

Your LP gas system will function at low temperatures, provided the system components are kept at a temperature above the vapor point of the LP gas. Ask your LP gas supplier or your motor home dealer for information on product blends available in your area and the areas in which you will be traveling.

USING LP GAS SYSTEM AT LOW TEMPERATURES

The following chart shows the reduction in available BTU's/hour under various fill levels as the temperature drops:

% FULL	20 lb. Tank*				
	+ 20°	0°	-5°	-10°	-15°
60%	36,000	18,000	12,750	8,500	4,250
50%	32,400	18,200	12,150	8,100	4,050
40%	28,800	14,400	11,400	7,600	3,800
30%	25,200	12,600	10,450	7,300	3,150
20%	21,600	10,800	8,100	5,400	2,700
10%	16,200	8,100	6,075	4,050	2,025

*30 lb. Tank multiply x 1.40

The chart clearly shows how the availability of the gas is reduced at lower temperatures. With this in mind, keep your LP tank as full as possible during cold weather. Check the BTU/hr rating plates on your LP gas appliances. This information will help you manage your LP gas requirements efficiently.

LP gas systems can and do freeze up in very cold weather. It is a common misconception that the regulator or the gas itself freezes. Actually, it is moisture or water vapor that gets trapped in the system or absorbed by the gas that freezes and causes the problem. This ice can build up and partially or totally block the gas supply.

LP Gas System

There are a number of things you can do to prevent freeze up:

1. Be sure the gas tank is totally moisture-free before it is filled. If you are not sure, have an LP service station inject an approved antifreeze or deicer into the tank.
2. Be sure the tank is not overfilled. This is also a safety consideration.
3. Have the gas tank purged by the LP gas service station if freeze up occurs.
4. Be sure you have the proper gas blend for your traveling area. If you have the proper gas blend, it is very unlikely that the gas is at fault.

If, despite precaution, you do experience freeze up, ask your LP gas supplier to service the tank or regulator as required.

To fill the storage tank, drive the vehicle to an LP gas supplier or a service station which sells LP gas. Do not attempt to fill the tank yourself.

FILLING LP GAS TANKS

 **WARNING**

Do not fill LP gas containers to more than 80% capacity. Overfilling can result in uncontrolled gas flow which can cause fire and explosion. A properly filled container holds about 80% of its volume as liquid.

 **WARNING**

Turn off LP gas main valve before filling LP gas tank or entering an LP gas bulk plant or motor fuel service station. Turn off all pilot lights and appliances individually before refueling of motor fuel tanks and/or LP gas containers. When not individually turned off, automatic ignition appliances may continue to spark when LP gas is turned off at the container.

LP GAS SYSTEM LEAK CHECKS

The smell of LP gas (actually, an additive, ethyl mercaptan) indicates a leak. Obvious leak sources are fittings, valves and couplings.

For your safety, check for leaks in your gas system each time the tank is filled and before each trip. Always check the system any time you detect a garlic-like odor. Listen for a sustained hiss or hum when you turn the gas on. This may indicate a leak.

The first time you have your LP tank filled, have the serviceman bleed a little LP gas out of the small outage valve (this also lets you check that the bottle is not overfilled) and note the odor for future reference. A small number of people cannot smell this odor; if you are one of these you must take extra care in checking for leaks, as well as whenever you use LP gas appliances.

To perform a leak check:

1. Swab a mixture of a non-ammoniated, non-chlorinated soap solution or an approved leak detection solution over each fitting, joint and connection in the system.
2. Open the tank service valve.
3. Inspect each joint.
4. If even the smallest bubbles appear at any joint, this joint must be re-made. Refer repairs to an authorized Fleetwood service center or your LP gas service facility. Never attempt to repair gas piping without proper tools and know-how.

Potential trouble spots for leaks are areas where piping runs close to chassis and frame members. Look for chafes and cracks around pipe hangers. If you find defects in any LP gas system component, have it repaired or replaced before using the system.

	WARNING
Never check for leaks with an open flame. Do not check for leaks using ammoniated or chlorinated household type detergents. These can cause cracks to form on the metal tubing and brass fittings. If the leak cannot be located, take the unit to an LP gas service representative.	

LP GAS SYSTEM

As an added precaution, do a visual check of all exposed piping and fittings after you have arrived at a destination and before you use the LP gas system. Travel and road shocks may have caused damage to the system that you will need to repair before using the appliances.

Keep the tank valve closed and turn off all appliances if the unit is not being used.

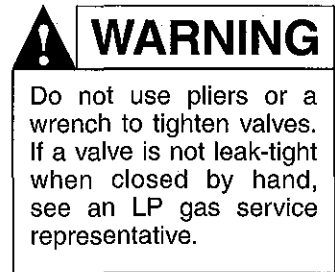

A permanently installed LP gas leak detector is located near the floor. The unit contains an alarm that will sound alerting you to the presence of low levels of potentially dangerous LP gas that may have been released due to a gas leak. The unit will also disconnect the gas supply at the LP tank when it senses LP or similar gases such as hair spray or cleaning solvent.

LP LEAK DETECTOR

The detector unit is powered by the 12-volt DC system in your motor home. A power switch is located on the panel. A green light on the detector front panel indicates that the detector has power. If the power switch is OFF, gas flow from the tank is cut off by a special solenoid valve located at the tank.

Test the leak detector each time the motor home is relocated and set up for use.

Testing Procedure:

1. Hold a butane-fueled pocket lighter near the sensor.
2. Open the lighter valve without striking the flame. The leak detector should respond within a few seconds.
3. Switch the unit OFF then ON to reset the alarm.
4. Lightly fan the area around the detector to insure complete dispersion of the gas from the lighter, and to prevent another sounding of the alarm.

If the alarm does not sound during a test or if the green indicator light is not visible, see your dealer or an authorized Fleetwood Service Center. There are no batteries or user serviceable parts inside the unit.



NOTE

Remember to turn off the detector if you are not using your motor home. The detector draws enough current to discharge your battery.

Detailed operating information for the LP gas appliances can be found in your *Owner's Information Package*. Please read and follow these instructions

Air trapped in the gas lines may delay the initial lighting of any appliance. It could take several seconds or minutes for the gas to reach the appliance. To purge some of the air from the gas system, first light a burner on the range. The other appliances will then light more quickly.

We recommend lighting the pilot light at the range, if equipped, rather than individually lighting each burner. This will help prevent accidental leaks at the burner. Be sure the pilot light is extinguished while traveling.

LIGHTING LP GAS APPLIANCES

LP GAS SYSTEM

The first time the furnace or oven is operated, paints and oils used in its manufacture may generate some smoke and fumes. If this occurs, open doors and windows to air out the motor home. These materials should burn off after the first 15 to 20 minutes of appliance operation.

Always follow the appliance manufacturer's lighting and operating instructions.

APPLIANCES

The appliances installed in your motor home are tested by independent laboratories and comply with rigid standards established by these organizations. All appliances are covered by Fleetwood's *Ownercare Warranty* program. Each appliance is also warranted by its manufacturer.



NOTE

The individual appliance manuals included in your **Owner's Information Package** contain detailed operating and maintenance instructions. Always refer to the respective manual for the appliance in question.



WARNING

The water heater and furnace combustion air exhaust ports may be extremely hot during water heater and furnace operation. Do not touch these outlets or allow any material to come within close proximity of exhaust ports while operating the water heater and/or furnace.

The water heater operates on LP gas, and is much like the one in your home. It contains an automatic shut off valve, which stops the gas supply if the water temperature rises too high. The water heater is reached through an access panel on the outside of the motor home.

Turn on the hot water faucet at the galley sink. If water flows continuously, the heater is full.

WATER HEATER



CAUTION

Do not light water heater until it is filled with water.

Appliances

Consult the operating instructions furnished in your *Owner's Information Package*. Before operating the refrigerator when the motor home is parked, make sure it is level. If it is not level, the refrigerant will not circulate, cooling action will stop, and the refrigeration system may be damaged.

The refrigerator uses the absorption principle of operation. If you plan to cool food or drinks in high outside temperatures, pre-cool the food, and park the motor home with the refrigerator vent door in the shade. Once the interior of the refrigerator is cool, the refrigeration system will usually maintain this temperature. If the inside of the refrigerator is hot, the food is not pre-cooled, and the outside temperature is high, be prepared for longer cooling times.

Some refrigerator models are equipped with a decorative enamel door panel. Use a cleaner specially formulated for enamel and a soft cloth to clean this surface. Do not use harsh or abrasive detergents or cleansers.

The forced-air furnace is fueled by LP gas. All furnaces are equipped with a wall thermostat for individual temperature settings.

The furnace will not operate properly if your stored personal items block the free flow of air at the registers or the return air to the furnace. Storage under cabinets should be done carefully so as to not crush or damage the furnace ducting.

Smoke and fumes created as a result of burning off manufacturing compounds are sometimes present the first time the furnace is used. This is normal; however, the initial light off should be done with windows and doors open and be of adequate duration to completely burn off the residue.

REFRIGERATOR

REFRIGERATOR DOOR PANELS

FURNACE

If the furnace is unable to keep you comfortably warm, **NEVER** use the range, oven or a catalytic heater for supplementary heat—even with a vent or window open.

The RV furnace is designed to get its combustion air from outside the RV and discharge the products of combustion to the outside again for safe operation. Open flames in the RV can deplete the available oxygen in the vehicle and replace it with carbon monoxide. The use of the range or oven for the short periods necessary for cooking or baking should present no problem IF you also open a vent or window to provide ventilation whenever they are used, assuming you are also alert and awake.

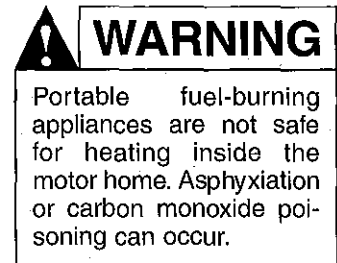

The gas oven and burners are operated with LP gas. The basic operation is the same as the range in your home.

RANGE

A warning label has been located in the cooking area to remind you to provide an adequate supply of fresh air for combustion. Unlike homes, the amount of oxygen is limited in an RV due to the size and construction of the vehicle. Proper ventilation when using the cooking appliances will prevent the dangers of asphyxiation. Refer to *Lighting LP Gas Appliances* section in the *LP Gas System* chapter of this manual.

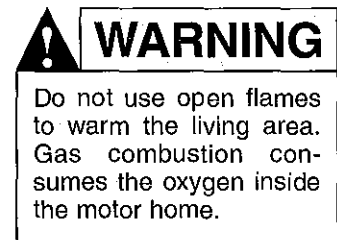

Appliances

The exhaust hood allows vapors and cooking odors to escape, and provides a vent for the galley area. Switches for the fan and light are located on the front of the hood. The hood has a grease filter screen which requires periodic cleaning. To clean, remove the screen and wash in soapy water. Rinse with water and let the screen dry before replacing it. The fan blades may also be cleaned with soapy water. Replace the light bulb with an equivalent type.

The range hood may also house the monitor panel. Operating instructions for the monitor panel functions are in the *Living With Your Motor Home* chapter of this manual.

RANGE HEAD EXHAUST HOOD

The optional roof-mounted air conditioner can operate only when the motor home is connected to 120-volt AC power from either a public utility or the generator. Be sure to turn the air conditioner circuit breaker ON.

For best performance, park the motor home in the shade and close curtains. Close doors and windows. Set thermostat for desired coolness. Refer to the air conditioner manufacturer's instructions for detailed operating and preventive maintenance requirements. Remember that air conditioners use a large portion of your available electrical power.

DUCTED AIR CONDITIONER (OPTIONAL)

Appliances

If additional equipment requiring 12-volt power is installed in the motor home, obtain the 12-volt source from a properly fused battery circuit. Consult an authorized Fleetwood dealer before adding any additional equipment to your motor home.

ENTERTAINMENT EQUIPMENT

The optional 120-volt TV and VCR can operate only when the motor home is connected to 120-volt power from either a public utility or the generator.

120-VOLT TV AND VCR (OPTIONAL)

The optional 120-volt/12-volt television can operate from a 12-volt power source (battery) as the motor home is delivered. Care should be taken so the batteries are not drained while using the TV on 12-volt power.

120/12-VOLT TELEVISION (OPTIONAL)

The television can also be operated on 120-volt power from the generator or public utility by removing the 12-volt cord from the rear of the TV and installing the 120-volt cord. Both 120- and 12-volt cords cannot be used at the same time. To use TV on 12-volt power, the cords must be exchanged.

The roof-mounted antenna is designed for reception of VHF and UHF television signals.

TV ANTENNA

Before traveling, remember to lower the antenna and secure it to prevent damage to the antenna, motor home roof, or objects in the path of the antenna, such as overhead wires.
Do not travel with the antenna raised.

✓	NOTE
The antenna booster power supply must be turned off to prevent battery drain. A red indicator light will glow when the unit is on.	

Appliances

The television and radio systems in your RV have been chosen to provide good performance under varied signal conditions. Occasionally, though, you may experience *ghosts* on TV, *flutter* when listening to FM broadcasts, or other signal interference.

The fault is normally not with your receiver. Neither is your antenna system usually at fault. The idea that antennas, whether amplified or unamplified, “pull in” a signal is a popular misconception. An antenna does not pull a signal out of the air by virtue of its “power.” The antenna only responds to signals present at the antenna elements. Antennas with boosters only amplify these signals.

Since distance from the broadcast tower is critical to reception clarity, remember that TV and FM signals have a range of only about 75 miles under the best of atmospheric and geographic conditions. The good reception you get at parks located at great distances from broadcast facilities is probably the result of satellite, microwave or other cable distribution systems. The antenna on your RV is no competition for these very expensive installations.

In addition, TV and radio frequency interference results from the electromagnetic fields produced by electric arc discharge. This arcing is found in lightning, vehicle ignition systems, and in 12 volt DC (brush type) motors used in power vents and furnaces. Note that nearly every DC motor has brushes. Most alternating current (AC) motors do not have brushes, and therefore do not generate the arcing interference. This is why this type of interference is less noticeable in a household environment.

TV AND RADIO INTERFERENCE

As the signal diminishes with distance and geographical features (mountains, etc.), the effect of electric arc interference may become more and more noticeable. Eventually, the signal will be overcome by the interference. The following suggestions can improve reception:

- » Use the "park cable" TV antenna system of your RV in remote areas rather than the roof antenna if the campground provides cable hook-up. (Turn off antenna booster when using park cable.)
- » Turn the television antenna. Sometimes turning the antenna will pick up a stronger signal. Try turning or rotating the antenna throughout its range. You may find your signal in a very unexpected direction.
- » With FM stereo signals, switch the unit to MONO, if possible. Some of the phase and noise components of a stereo signal will disappear in MONO mode.
- » Reduce the treble setting to reduce background noise. Although not yielding the best high-frequency performance, at least you may be able to reduce the irritation of the distortion and noise.

You may have additional appliances in your unit which operate only when connected to 120-volt power from either a public utility or the generator.

In some cases appliance selector switches are provided on the galley to allow you a selection of appliances yet still remain within the power capacity of the electrical system.

MISCELLANEOUS APPLIANCES

This page intentionally blank.

MAINTENANCE

Your motor home has been designed to provide you with many years of use with a minimum amount of maintenance. This section will familiarize you with the areas of your motor home that require scheduled care. Time spent taking care of your motor home on a regular basis will pay for itself in extended service and will protect your investment. If you are mechanically inclined and regularly perform routine maintenance and repairs on your car or truck, you may want to do the mechanical work on your motor home yourself. If you prefer, your dealer can perform these services for you. His trained personnel will assure that your motor home is maintained and repaired in keeping with original performance expectations.

This section is intended to provide the owner and operator with a general overview of service and maintenance information for the motor home. Detailed service and maintenance information may be found in the owner's/operator's manuals contained in the *Owner's Information Package*.

While the information in this section is intended to establish proper maintenance and inspection procedures, there may be times when detailed diagnostic and repair procedures may be required. Consult your dealer or an authorized Fleetwood Service Center in these situations.

MAINTENANCE

Some exterior parts of your motor home are made of fiberglass. The finish on these parts is durable, but not indestructible. Any material and finish will deteriorate in time. Exposure to sunlight, moisture and airborne pollutants can cause dulling and fading of the finish. Generally, changes in the finish due to weathering are cosmetic — they are on the surface of the part and do not affect its strength. Weathering can take the form of chalking, fading and yellowing.

The best insurance against these effects is routine maintenance. If the finish is not washed and waxed thoroughly, the surface can deteriorate very rapidly. The following maintenance guidelines can help you reduce these weathering effects:

1. Wash the exterior with a mild soap monthly, at least. Avoid strong alkaline cleaners and abrasives.
2. Wax the exterior at least once a year — twice, if possible — with a wax formulated for fiberglass. When waxing, always read and follow the instructions and precautions on the container. Some cleaners and waxes are recommended for use on only certain types of surfaces. In some cases, a light rubbing compound may be required. Always follow rubbing compound with a high-quality wax.

Stains are generally caused by two types of substances — water soluble and non-water soluble. Water soluble stains can usually be washed away with water and mild detergent. Follow the washing with wax.

Non-water soluble stains are usually oil-based. Removal of this type of stain may require the use of highly flammable or poisonous solvents. Refer this type of service to your dealer or an authorized Fleetwood Service Center. Never use strong solvents or abrasives to clean plastic surfaces.

EXTERIOR

STAINS

Keep moving parts, hinges and latches adjusted and maintained. Lubricate with a light oil at least once a year. Check and tighten the screws holding the windows in place as required. Clean screens by gently wiping with a damp cloth or soft flat brush. Not all screens are removable.

WINDOWS, DOORS, VENTS AND LOCKS

Inspect the sealants around doors and windows every three months. See *Sealant Renewal* section.

Lubricate locksets in doors and exterior storage compartments at least annually with powdered graphite. If the motor home is located at a beach or is exposed to salt air, more frequent lubrication may be required.

For normal cleaning, standard household detergents or cleansers may be used. Use a non-abrasive, common household detergent and plenty of water. Be sure to keep the sidewalls wet to reduce streaking. Road tar, tree sap or other stubborn stains can be removed with a soft rag and xylene.

RUBBER ROOF SYSTEM

CLEANING

WARNING

Xylene is a flammable liquid. Use extreme care when handling and using. Do not expose to open flame, spark or smoking material. Do not use in unventilated area.

The rubber roof itself does not require annual coatings or additional sealants. Periodic washing with soap and water is all that is required.

CARE

The rubber roof material can be cut by sharp objects. If you add accessories or new equipment on the roof, be sure the installer is qualified to work on the rubber roof material. This is required under the terms of the warranty.

WARNING

Rubber roof material is slippery when wet.

Repair kits are available through your dealer. The roof requires special adhesives and material.

MAINTENANCE

The adhesives and sealants used in the construction of your motor home were developed to remain waterproof under sustained effects of weather and vibration. However, even the finest materials will eventually dry out and lose their effectiveness under constant heat of the sun and attack by other elements. This section outlines the procedures you must follow to maintain the weatherproof integrity of your motor home. Leak damage caused by failure to follow these procedures may affect your warranty coverage.

Your dealer can perform the resealing inspection and work for you. Your dealer also has current information on sealants used in your motor home, and can recommend the appropriate sealants for you if you prefer to do this work yourself. Always use the recommended sealants.

Inspect the sealants around windows and doors at least every three months. Also inspect roof vents, other roof components, moldings at front and rear caps, and perimeter molding. If any of the following defects are evident during inspection, the affected areas must be resealed.

- » Excessive amount of sealant protruding from joints.
- » Sealant cracked or peeling.
- » Voids in sealant.

If you find any of the above defects:

1. Use a plastic scraper to remove excess sealant, any cracked or peeled sealant, or any voids in the sealant.
2. Clean all areas to be resealed with mineral spirits and clean rags.
3. Make sure that all areas to be resealed are absolutely dry before new sealant is applied.

SEALANT RENEWAL

DOOR, WINDOW, ROOF COMPONENT AND MOLDING RESEALING

 **NOTE**

Do not seal the bottom flanges of windows and doors. Sealant voids have been intentionally left in the bottom flange to provide exterior drainage in the event of leakage.

 **WARNING**

Mineral spirits is a flammable liquid. Use extreme care when handling and using. Do not expose to open flame, sparks, or smoking material. Do not use in unventilated areas.

Interior appointments such as draperies, bedspreads, mattress covers, upholstery and wall pads are manufactured from high quality synthetic materials and should be dry cleaned only. Frequent vacuuming will keep them free of dust and dirt. Minor spills should be cleaned up quickly to avoid staining. The affected area should be blotted, not rubbed, to prevent the stain from working deeper into the fabric.

INTERIOR

FABRICS



WARNING

Do not use lacquer thinner, nail polish remover, carbon tetrachloride, spot remover, gasoline, or naphtha for any cleaning purpose. These products may cause damage to the material being cleaned, and may be highly flammable or poisonous.

For cleaning laminate surfaces, use a mild dishwashing liquid with warm water. Use a soft cloth for both washing and drying.

LAMINATE TOP CARE

Do not use abrasive cleaners, steel wool, or gritty cleaners or damage will occur to the surface.

The paneling and the ceiling of your motor home may be any of several finishes and textures. Never use harsh detergents or abrasive cleaners on walls or ceilings. Most surfaces will clean with a soft cloth moistened with mild liquid detergent in warm water. Do not use large amounts of water which could saturate the material.

WALLS AND CEILING PANELS

MAINTENANCE

Some cleaners attack the plastic causing it to discolor and become brittle. The following cleaners have been tested and approved when mixed with water: Distilled vinegar, mild dishwasher detergent, or liquid deodorizing cleaner. Avoid cleaners with any level of abrasives, acetone or MEK (methyl ethyl ketone).

BATHTUB AND PLASTIC SHOWER STALL

Vinyl flooring requires only washing and periodic waxing. Vacuum carpeting regularly, and clean it with a quality carpet cleaner. Do not use water or waxes mixed with water on wood floor.

FLOORS AND CARPETING

The top of the engine may be accessed for service by removing the engine cover.

ENGINE ACCESS



WARNING

When installing the engine cover, be sure the cover is fully seated on the gasket seal and secured by the cover screws or clamps. Do not allow carpeting, floor mats or other material to interrupt the seal between the cover and the engine compartment. If the engine cover is not installed correctly, engine exhaust gases could leak into the passenger compartment creating a safety hazard. If the engine must be run with the engine cover off for maintenance purposes, be sure the vehicle interior is adequately ventilated.

For your convenience, a maintenance checklist is included in this manual. This comprehensive list is the most up to date available at the time of publication. Options and accessories usually have their own owner/user manuals that often contain added maintenance instructions. Consult these manuals as required.

MAINTENANCE CHECKLIST

MAINTENANCE CHART

	A	B	C	D	E	F	G	H	I	J
Wash exterior		●								
Wax exterior						●				
Lubricate and adjust exterior locks, hinges and window mechanisms							●			
Lubricate TV antenna	●					●		●		
Check all exterior sealants, around windows, doors, sidewall seams, windshield, lamps, all exterior openings and roof components. Re-seal if necessary.	●				●			●		
Inspect and clean fuel-fired appliance vents: Water heater, refrigerator, furnace.	●			●			●	●		
Inspect and test safety equipment: Fire extinguisher, LP, CO and smoke detectors, and GFCI receptacles.	●			●						
Service appliances and equipment: refrigerator, roof air conditioner, furnace, generator	●								●	
Inspect generator exhaust system	●		●					●		
Inspect LPG system including leak check	●	●						●		
Sanitize fresh water tank	●				●					
Clean drapes and interior fabrics	●					●				
Check exterior lamp operation	●					●				
Re-torque U-bolts (Mor-Ryde equipped only)									●	
Chassis										●
Inspect fire extinguisher									●	
Check smoke detector operation	●									
Check LPG leak detector operation	●									

A - Start of Season

B - Each Trip or Monthly

C - Every 8 Hours

D - Weekly

E - Every 3 Months

F - Every 6 Month

G - Each Year

H - End of season

I - At Specified Mileage or Interval

J - At Specified Mileage for Heavy Duty Service

This page intentionally blank.

MOTOR HOME STORAGE

The following checklists will help you perform the steps necessary to prepare your motor home for storage. Use the checklist that applies to the storage conditions you anticipate.

These checklists do not include every detail required, and you may want to expand them to suit your needs. Contact your dealer for additional suggestions suitable to your climate and storage conditions, particularly extremes of hot and cold.

STORAGE CHECKLISTS

- Wash the motor home exterior and underside. Hose off accumulations of mud and road salts.
- Thoroughly clean the interior of the motor home, including carpets, counter tops, lavy, tub and shower, and galley.
- Inflate tires to maximum rated cold pressure.
- Park the motor home as level as possible front to rear and side to side. Block wheels front and rear, and leave the parking brake OFF.
- Check the charge in the battery. Recharge as necessary.
- Remove battery cables. Refer to *Chassis Owner's Manual* for proper removal and installation sequence. Clean terminals, top and sides of batteries and battery boxes. Reinstall cables, dress with a plastic ignition spray.
- Use battery disconnect switch/es, if equipped.
- Drain holding tanks, toilet, and fresh water tank.

SHORT-TERM STORAGE (LESS THAN 60 DAYS)

MOTOR HOME STORAGE

- Turn off water pump and water heater master switches.
- Turn off LP gas at tank valve.
- Turn off refrigerator and furnace.
- Turn off all range and oven burner valves and pilot valves (if equipped).
- Remove all perishables from refrigerator and galley cabinets. Block refrigerator open to reduce odor buildup. An open box or tray of baking soda in the refrigerator will help absorb odors.
- Open closet doors, drawers, and cabinets so air can circulate.
- Slightly open (1/4") roof vents, at front and rear for ventilation. If the motor home is being stored below freezing, close and cover all vents to prevent entry of snow or small animals and insects.
- Close and lock all windows. Be sure vent fan and range hood fan switches are off.
- Cover exterior appliance vents (water heater, furnace, range hood, refrigerator) to prevent insects from getting in. Be sure to remove all covering material before using appliances or vents.
- Cap or close holding tank drain, city water inlet and fresh water fill spout.
- Turn off all radios, TVs, interior and exterior lights.
- Close curtains and/or mini-blinds, and pull shades.
- Disconnect the 120-volt power cord, and store in compartment.

MOTOR HOME STORAGE

- Cover tires with cloth, plywood, or aftermarket tire covers.
- Prepare generator (if equipped). Refer to *Generator Operating Manual* included in your *Owner's Information Package*.
- Run the engine for about 15 minutes every 30 days. Turn the vehicle air conditioner ON during this run. Check engine oil, transmission fluid and coolant levels.

-
- Perform all steps as required for short-term storage.
 - Run engine to normal operating temperature. Operate air conditioner to lubricate compressor seals. Drain engine oil, replace filter, refill engine with fresh oil.
 - Remove windshield wiper blades and store inside the motor home.
 - Charge and remove both the vehicle and auxiliary batteries. Store them in a cool, dry place, and check the charge and water level every 30 days. For batteries with non-removable vent caps, check the specific gravity of the electrolyte periodically with a hydrometer or boost charge every three months. If the specific gravity is being checked, recharge the battery when it reaches 1.220. The time it takes the battery to reach 1.220 depends on its condition and the temperature. The colder the storage area, the slower the battery will self-discharge. A normal time between charges is three months.
 - Remove, clean and replace air conditioner filters. Cover the air conditioner shroud(s).

LONG-TERM STORAGE (OVER 60 DAYS)

MOTOR HOME STORAGE

- Cover the windows on the inside with foil, cardboard, paper, etc., to reduce curtain, drape, and carpet fading.
- Remove batteries in clocks or other battery-powered devices.
- During extended periods of storage, gasoline may deteriorate due to oxidation. This can damage rubber and other materials in the fuel system such as carburetor, accelerator pump, diaphragms, and carburetor inlet valves. It may also clog small orifices. Commercially available gasoline fuel stabilizers may be added whenever actual or expected storage periods exceed 60 days. Follow the additive manufacturer's instructions. Operate the vehicle regularly during the storage period to mix and circulate the anti-oxidant agent throughout the fuel system.
- Check tire inflation pressures every 30 days. Maintain maximum rated cold inflation pressure.
- Check the sealant around all roof and body seams and windows. Reseal if necessary. See *Sealant Renewal* section.
- Lubricate all locks and hinges as described in the *Maintenance* chapter.
- Remove high grass or weed growth.

Thoughtful planning and preparation for the winter season can help eliminate equipment failures and breakdowns, and can extend the life of your motor home and its systems. Your dealer can advise you concerning specific winterization procedures and products for your climate area or the areas through which you will be traveling. Your dealer may also provide winterization service for all appliances and systems in the motor home. The following is a check list if you prefer to perform these procedures yourself:

WINTERIZATION

- Check engine coolant level and antifreeze protection. Drain and flush engine cooling system and add antifreeze to protect the system to the lowest expected storage temperature or at least -20° F.
- Service and winterize the generator (if equipped) as outlined in the generator operating manual included in your *Owner's Information Package*.
- Winterize the LP gas system. Your LP dealer or service station will perform this for you.
- Winterize all appliances as outlined in the individual operator's manuals.
- Remove snow accumulations as often as possible.

Read this section completely before performing winterization.

WATER SYSTEM WINTERIZING

- Remove water purifier filter cartridge, if equipped, and install the winterizing plug.
- Drain the fresh water tank by opening the water tank drain valve. Leave valve open.
- Turn water pump on (12-volt power must be on). Open a cold water faucet. When the flow of water stops, turn the pump off.

MOTOR HOME STORAGE

- Open water faucets, then open the drain valves on HOT and COLD water pipes. Leave these valves open.
- Drain the water heater by opening the drain plug at the bottom of the heater and the safety valve at the top.
- Flush the toilet. Operate toilet sprayer, if equipped.
- Drain the shower head by opening the valve. Let all water drain out the tub spout. Leave the valve open.
- When each faucet has been drained, close all faucets, water line drain valves and the fresh water tank drain valve, install the water heater plug and close the safety valve.
- Drain the waste water system by following the normal procedure for draining the holding tanks. (See *Plumbing* chapter).
- Apply silicone lubrication to the knife valve actuator rod(s).
- Be sure ALL water from ALL plumbing fixtures has been drained.
- Close holding tank drain valves.
- Pour approximately five gallons of approved non-toxic antifreeze into the fresh water tank.
- Turn the water pump master switch ON.
- Open each cold water faucet, run the water pump and let about a cup of antifreeze solution flow continuously through each faucet. Close each cold water faucet.
- Flush the toilet until the antifreeze solution flows continuously. Release flush mechanism.

CAUTION

Draining the water system alone will not provide adequate cold weather protection. If the motor home is to be unheated during freezing temperatures, consult your dealer for the best winterizing procedure for your climate. Your dealer can winterize your motor home for you or can supply you with one of the special antifreezes which are safe and approved for use in RV water systems. Follow the instructions furnished with the antifreeze.

WARNING

Do not use automotive or windshield washer antifreeze in the motor home water system. These solutions may be harmful if swallowed.

MOTOR HOME STORAGE

- If your vehicle is equipped with a water heater bypass, winterize the water heater according to the instructions provided with the water heater operating manual. If you do not have a bypass, you will have to fill the water heater with antifreeze solution by the water pump. Winterize the hot water lines by opening each hot water faucet, allowing antifreeze solution to flow continuously, and then close each faucet. This will require considerably more antifreeze solution, and you may choose to do this step before winterizing the cold water lines so you can recycle the solution.

- When filling the plumbing systems with antifreeze, be sure to open and operate all fixtures and valves allowing the antifreeze solution to flow freely.

- Pour one cup of antifreeze solution down each drain.

- Install all protective caps:
 - Water tank fill
 - City water inlet cap
 - Waste tank drain outlet cap

MOTOR HOME STORAGE

If the motor home was properly and carefully prepared for storage, taking it out of storage will not be difficult. The following procedure check list assumes that you stored the motor home with care. If you didn't, and extensive freeze damage or other serious deterioration has occurred, please consult your dealer or an authorized Fleetwood Service Center for advice.

REACTIVATING THE MOTOR HOME AFTER STORAGE

- Thoroughly inspect the outside of the vehicle. Look for animal nests in wheel wells, under the hood, in air cleaner or in other out of the way places.
- Remove all appliance vents, ceiling vent and air conditioner coverings. Be sure all furnace, water heater, and refrigerator openings are clear and free of debris or insect nests, webs, etc.
- Open all doors and compartments. Check for animal or insect intrusion, water damage, or other deterioration.
- Check all chassis fluid levels — engine oil, engine coolant, power steering fluid, brake fluid, transmission fluid, rear axle oil.
- Check charge level in batteries. Refill and recharge as necessary. Reinstall batteries if necessary. Be sure cable ends and terminals are clean and free of corrosion.
- Check tire pressures. Reinflate to specified cold pressure.
- Remove covering from inside windows.
- Open vents and windows for ventilation.
- Be sure engine instruments indicate proper readings. Run engine up to operating temperature. Shut engine down. Check all fluids. Top up if necessary.

- During engine run, check the operation of headlights, tail-lights, turn signals, backup lights, clearance lights, license plate light, emergency flashers. Operate the vehicle air conditioner. If air conditioner does not work, or unusual sounds occur, have the system checked by a qualified air conditioner technician.
- Drain, flush, and sanitize the fresh water system as outlined in the *Plumbing* chapter. Inspect the drain hose for leaks. Replace if necessary — repairs are usually not effective.
- Install a new water purifier cartridge (if equipped).
- Operate all faucets and fixtures in the fresh water system. Check for leaks at all joints and fittings. Repair if necessary.
- Check 12-volt circuit breakers and inspect fuses.
- Operate all 12-volt lights and accessories.
- Install new batteries in battery-operated devices. Check operator's manual for each device for additional requirements.
- Test carbon monoxide, LP gas and smoke detectors.
- Check monitor panel operation.
- Open and operate vents and vent fans, including the range hood fan.
- Inspect the 120-volt electrical system — power cord, converter, all outlets, and any exposed wiring. If defects are found, refer service to your dealer or an authorized Fleetwood Service Center.

MOTOR HOME STORAGE

- Prepare the generator for operation following instructions in the generator operating manual in your *Owner's Information Package*.
- Start and run generator.
- Operate 120-volt appliances and air conditioners. Be sure to uncover air conditioner shroud(s).
- Inspect the LP gas system and check for leaks as described in the *LP Gas System* chapter. If the LP tank shows signs of rust or corrosion, have it inspected by a qualified LPG technician.
- Operate each LP gas appliance. Observe all burner/pilot flames for proper color and size. In any case, have the LP gas regulator adjusted for proper pressure by a qualified technician.
- Inspect and clean the interior.
- Check the sealant around all roof and body seams and windows. Reseal if necessary. See *Sealant Renewal* section.
- Lubricate all exterior locks, hinges, and latches.
- Reinstall windshield wiper blades. Check wiper/washer operation.

MOTOR HOME STORAGE

- Wash and wax the exterior. Inspect the body for scratches or other damage. Touch up or repair as necessary. Flush the underside thoroughly.

- Run thorough operational checks of steering, brakes, engine and transmission. Operate vehicle slowly during these checks to allow sufficient circulation of fluids and reseating of components.

Your motor home should now be ready for a new traveling season. If you choose, your dealer can double check your preparation and correct any defects or make any necessary adjustments.

This page intentionally blank.

GLOSSARY

AC INVERTER - An electronic device that changes 12-volt DC energy from the batteries to 120-volt 60-cycle, AC energy to operate microwave ovens, TVs, VCRs, or other appliances that require 120-volt 60-cycle power.

BELTED SEATING POSITIONS - These are seats with seat belts. These seats define the legal passenger carrying capacity of the motor home. Anyone riding in the motor home must use one of these seats any time the motor home is in motion.

BLACK WATER TANK - The water tank in your plumbing system that is designed to contain waste water from the toilet ONLY.

CAUTION - Any statement in this *Owner's Manual* that, if not followed, could result in damage to the vehicle or components.

CHASSIS OPERATOR'S MANUAL - This is the operating and maintenance manual supplied by the chassis manufacturer. It is part of your *Owner's Information Package*. It contains information on operating and maintaining the engine, transmission, drive-train and other components of the motor home chassis.

DC CONVERTER - An electronic device that changes 120-volt AC energy from the main power connection or the generator to 12-volt DC energy to operate the 12-volt interior lights or other 12-volt DC appliances or accessories.

DOORSIDE - The right side of the motor home from the driver's point of view. So named because the main entry/exit door is usually on this side.

FIN (FLEETWOOD IDENTIFICATION NUMBER) - This is the number that identifies your motor home as a Fleetwood product. Use this number when ordering parts or requesting warranty service for your motor home.

Glossary

GAWR (Gross Axle Weight Rating) - The maximum allowable weight a specific axle and brake system is designed to carry. Each axle has its own GAWR. When you add the GAWRs, they will not necessarily add up to the GVWR. The GAWR is also shown on the Federal certification tag posted on the left interior sidewall near the driver's station.

GCWR (Gross Combined Weight Rating) - The maximum allowable combined weight of the fully equipped and loaded motor home (including passengers, all cargo, fluids, etc.) plus the weight of any fully loaded towed load (such as a trailer, boat, or automobile). The Gross Combined Weight Rating (GCWR) is listed on the wardrobe door tag. **If the towed unit is not equipped with brakes that are actuated with the motor home brakes, this number may be lower. The allowable weight of a non-brake equipped towed unit is listed in the Chassis Operator's Manual.** Exceeding the GCWR will cause damage to your motor home drivetrain or chassis, unstable driving and handling characteristics, and will reduce your warranty protection.

GEAR PRESELECTION - The selection of a lower gear to match the driving conditions you encounter or expect to encounter. Preselection will give you better control on slick or icy roads and on downgrades. Downshifting to lower gears increases engine braking. The selection of a lower gear often prevents cycling between a gear and the next higher gear on a series of short up-and-down hills.

GFCI (Ground Fault Circuit Interrupter) - An electrical device attached to the bathroom and galley AC circuits that disconnect the outlet if a problem occurs in the ground circuit.

GRAY WATER TANK - The water tank in your plumbing system that is designed to contain waste water from the sinks and shower drains ONLY. No toilet wastes go into this tank.

GTW (Gross Towing Weight) - The maximum allowable loaded weight that this motor home has been designed to tow and brake. This cannot be increased by changing the trailer hitch. The GTW is listed on the wardrobe door tag.

GVWR (Gross Vehicle Weight Rating) - The maximum allowable load that this motor home was designed to carry. Modifications to your motor home, such as installing bigger tires or changing spring load capacities, will not in any way increase this weight rating. The GVWR is shown on the Federal certification tag posted on the left interior sidewall near the driver's station.

MONITOR PANEL - An electronic device that allows you to conveniently measure the approximate levels in the fresh water, gray and black water tanks. You can also check the charge in the battery.

MTW (Maximum Tongue Weight) - The maximum vertical load that the towed load (such as a trailer or auto dolly) applies to the hitch of the motor home. The MTW is listed on the wardrobe door tag.

NOTE - A statement or instruction in this *Owner's Manual* with information to help you use the vehicle or equipment more efficiently, such as a tip.

OWNER'S INFORMATION PACKAGE - This is a package of papers, manuals, warranty and instruction cards, and other material put together for you by the motor home manufacturer. These materials contain operating and maintenance instructions for most of the components and appliances in your motor home.

Glossary

OWNERCARE CARD - The plastic "credit card" style card that has your name and vehicle ID (FIN) embossed on it. Use this card when you request or need warranty service. Please note that this is NOT a credit card. You cannot purchase anything with it. It is used only to identify you and your motor home.

Park Cable - The F-style video connector that allows you to connect to an outside television signal source, such as the cable TV feed at an RV park, or any other 75-ohm video source. This connector usually carries an RF modulated signal.

Park/City WATER CONNECTION - The "garden-hose" style connector that allows you to connect to an outside pressurized water source.

POWER/ShORE Cord - This is the main power cord coming into your motor home electrical system. You connect it to 120-volt AC power at a park or campsite.

Preelivery Inspection - This is the procedure required by the motor home manufacturer that your dealer performs before you take delivery of the motor home at the time of sale.

Roadside - The left side of the motor home from the driver's point of view. So named because, at least in North America, the "road" outside the vehicle is usually on this side.

UVW (Unloaded Vehicle Weight) - The calculated weight of the motor home, as built at the factory with full fuel, engine oil (and other engine/drivetrain fluids) and LP gas. The UVW does not include cargo, fresh water, holding tank contents, passengers, or accessories installed by the dealer. The UVW is listed on the wardrobe door tag.

VIN (Vehicle Identification Number) - The legal vehicle identification number as shown on the vehicle registration certificate.

WARNING - A statement or instruction in this *Owner's Manual* that, if not followed, could lead to personal injury.