

CLASS "C" MOTOR HOME
FLEETWOOD®RV

2000

©1999 by Fleetwood Enterprises, Inc. All rights reserved. No part of this publication may be reproduced or transmitted in any form or by any means, electronic or mechanical, including photocopying, recording, or by any information storage or retrieval system without written permission from Fleetwood Enterprises, Inc.

Manufacturing subsidiaries of Fleetwood Enterprises, Inc. build the following motor homes:
Pace Arrow • Pace Arrow Vision • Southwind • Southwind Storm • Bounder • Bounder Diesel
• Discovery • Flair • Tioga • Jamboree • American Eagle • American Dream • American Heritage
• American Tradition

This page intentionally blank.

**SAFETY REGULATIONS
REGARDING
LP GAS SYSTEMS AND
LP GAS APPLIANCES**

WARNING

It is not safe to use cooking appliances for comfort heating. Cooking appliances need fresh air for safe operation.

Before operation:

1. Open overhead vent or turn on exhaust fan, and
2. Open window.

This warning label has been located in the cooking area to remind you to provide an adequate supply of fresh air for combustion. Unlike homes, the amount of oxygen supply is limited due to the size of the recreational vehicle, and proper ventilation when using the cooking appliance(s) will avoid dangers of asphyxiation. It is especially important that cooking appliances not be used for comfort heating as the danger of asphyxiation is greater when the appliance is used for long periods of time.

WARNING

Portable fuel-burning equipment, including wood and charcoal grills and stoves, shall not be used inside this recreational vehicle. The use of this equipment inside the recreational vehicle may cause fires or asphyxiation.

WARNING

LP gas containers shall not be placed or stored inside the vehicle. LP gas containers are equipped with safety devices which relieve excessive pressure by discharging gas to the atmosphere.

Our forest product suppliers have advised that urea-formaldehyde is used in the production of particle board, hardwood plywood or paneling which they supply us and which we utilize in our finished product. These suppliers have requested that we communicate this to our customers.

IMPORTANT NOTICES



WARNING

This product is manufactured with urea-formaldehyde resin. Formaldehyde vapor may in some people cause headaches, eye, nose and throat irritation, and aggravation of allergies and respiratory problems, such as asthma. Proper ventilation should reduce the risk of such problems.

Champion International Corporation



WARNING

This product is manufactured with a urea-formaldehyde resin and will release small quantities of formaldehyde. Formaldehyde levels in the indoor air can cause temporary eye and respiratory irritation, and may aggravate respiratory conditions or allergies. Ventilation will reduce indoor formaldehyde levels.

Weyerhaeuser Corporation



WARNING

This motor home contains components containing or manufactured with 1,1,1 Trichloroethane, a substance that may be harmful to the public health and environment by destroying ozone in the upper atmosphere.



WARNING

Irritant: This product contains a urea-formaldehyde resin and may release formaldehyde vapors in low concentrations. Formaldehyde can be irritating to the eyes and upper respiratory system of especially susceptible persons such as those with allergies or respiratory ailments. Use with adequate ventilation. If symptoms develop, consult your physician.

Georgia-Pacific Corporation

Ventilation is important in maintaining a comfortable environment and we direct your attention to the discussion of ventilation contained in your Owner's Manual.

We are required to tell you consumer information provided by the National Fire Prevention Association (NFPA) and the American National Standards Institute (ANSI). The information and warnings found on these pages may also be found in other chapters of this *Owner's Manual*. Please see the *LP Gas System* and *Appliances* chapters for other safety and operating information.

SAFETY REGULATIONS REGARDING LP GAS SYSTEMS AND LP GAS APPLIANCES

WARNING

Do not bring or store LP gas containers, gasoline or other flammable liquids inside the vehicle because a fire or explosion may result.

A warning label has been located near the LP gas container. This label reads: **DO NOT FILL CONTAINER(S) TO MORE THAN 80-PERCENT OF CAPACITY.**

Overfilling the LP gas container can result in uncontrolled gas flow which can cause fire or explosion. A properly filled container will contain approximately 80- percent of its volume as liquid LP gas.

The following label has been placed in the vehicle near the range:

IF YOU SMELL GAS:

1. Extinguish any open flames, pilot lights, and all smoking materials.
2. Do not touch electrical switches.
3. Shut off the gas supply at the container valve(s) or gas supply connection.
4. Open doors and other ventilation openings.
5. Leave the area until the odor clears.
6. Have the gas system checked and leakage source corrected before using again.

LP gas regulators must always be installed with the diaphragm vent facing downward. Regulators that are not in compartments have been equipped with a protective cover. Make sure that regulator vent faces downward and the cover is kept in place to minimize vent blockage which could result in excessive gas pressure causing fire explosion.

WARRANTY SPECIAL NOTICES AND WARNINGS

INTRODUCTION.....	01-1
WARRANTIES.....	01-2
WARRANTY SERVICE.....	01-5
SUGGESTIONS FOR OBTAINING SERVICE FOR YOUR MOTOR HOME.....	01-6
REPORTING SAFETY DEFECTS.....	01-7
OWNER'S INFORMATION PACKAGE.....	01-7
CHASSIS AND VEHICLE IDENTIFICATION.....	01-8
SUSPENSION ALIGNMENT AND TIRE BALANCE.....	01-9
<i>AFTER-MARKET STEERING Aid DEVICES</i>	01-9
WARNINGS, TERMS AND CONCEPTS FOR SAFE OPERATION OF YOUR MOTOR HOME.....	01-10

ON THE ROAD.....	02-1
MOTOR HOME LOADING.....	02-1
<i>Responsibility for PROPER LOADING</i>	02-1
<i>SOME DEFINITIONS FIRST</i>	02-1
<i>TOWING A VEHICLE OR TRAILER</i>	02-3
<i>CARRYING CAPACITY AND LOAD DISTRIBUTION</i>	02-5
<i>CARRYING CAPACITY LABEL</i>	02-6
<i>HOW TO WEIGH YOUR LOADED MOTOR HOME</i> <i>WITHOUT A TRAILER OR OTHER TOWED LOAD</i>	02-7
<i>HOW TO WEIGH YOUR LOADED MOTOR HOME</i> <i>WITH A TRAILER OR OTHER TOWED LOAD</i>	02-9
<i>LOADING TIPS</i>	02-11
TIRES.....	02-12
<i>TIRE INFLATION</i>	02-12

Table of Contents

<i>TIRE REPLACEMENT</i>	02-13
<i>IF YOU GET A FLAT TIRE</i>	02-13
<i>SPARE TIRE CARRIER</i>	02-14
<i>CHANGING A FLAT TIRE</i>	02-14
SEATS AND SEAT BELTS	02-15
<i>COMBINATION LAP AND SHOULDER BELTS</i>	02-16
<i>SAFETY BELT MAINTENANCE</i>	02-16
<i>SAFETY RESTRAINTS FOR CHILDREN</i>	02-16
<i>SAFETY BELTS FOR CHILDREN</i>	02-17
<i>SAFETY SEATS FOR CHILDREN</i>	02-17
DRIVING AND VEHICLE CONTROL	02-18
MANEUVERING IN TRAFFIC	02-18
<i>USING THE ENGINE TO SLOW THE MOTOR HOME</i>	02-20
BODY UNDERCOATING	02-21
FUEL AND FUEL SYSTEMS.....	02-21
<i>FUEL TYPES AND VAPOR LOCK</i>	02-22
ENGINE FAN	02-22
EXHAUST SYSTEM HEAT	02-23
ENGINE TEMPERATURE GAUGES.....	02-23
CARBON MONOXIDE SAFETY PRECAUTIONS	02-24
<i>CARBON MONOXIDE DETECTOR/ALARM</i>	02-25
EMERGENCY TOWING.....	02-25
ATTACHING ACCESSORIES TO YOUR MOTOR HOME.....	02-26

LIVING WITH YOUR MOTOR HOME03-1

MANUAL ENTRY STEPS	03-1
POWER ENTRY STEPS	03-1
ENTRY ASSIST HANDLE	03-2
ENTRY DOORS AND SCREENS	03-2

Table of CONTENTS

Windows	03-2
<i>EMERGENCY Exit Window</i>	03-3
<i>Side Slider Windows</i>	03-3
SUN VISORS	03-3
Window SHADES (<i>SOME Models Only</i>).....	03-3
Mini-Blinds.....	03-4
STORAGE.....	03-4
<i>EXTERIOR COMPARTMENTS</i>	03-4
<i>INTERIOR STORAGE</i>	03-5
INTERIOR AND FURNISHINGS.....	03-5
<i>DINETTE CONVERSION</i>	03-5
<i>SOFA/LOUNGE CONVERSION</i>	03-6
<i>FOLDING DOORS/PRIVACY CURTAIN DIVIDERS</i>	03-6
<i>INTERIOR LIGHTING</i>	03-6
<i>OVERHEAD VENTS</i>	03-7
MONITOR PANEL.....	03-7
EFFECTS OF PERMANENT OCCUPANCY	03-8
<i>CONDENSATION AND HOW TO CONTROL It</i>	03-8
<i>DRIPPING CEILING VENTS</i>	03-14
FIRE SAFETY.....	03-14
<i>FIRE SAFETY PRECAUTIONS</i>	03-15
<i>SMOKE DETECTOR/ALARM</i>	03-16
<i>Slide-OUT ROOMS (SOME Models)</i>	03-16

PLUMBING SYSTEMS

FRESH WATER SYSTEM	04-1
<i>CITY WATER CONNECTION</i>	04-2
<i>THE WATER PUMP</i>	04-3
<i>WATER FILTER</i>	04-4
<i>TROUBLESHOOTING THE FRESH WATER SYSTEM</i>	04-4

Table of CONTENTS

<i>LEAKS</i>	04-4
<i>SANITIZING THE FRESH WATER SYSTEM</i>	04-5
<i>EXTERIOR SHOWER (SOME MODELS ONLY)</i>	04-6
WASTE WATER SYSTEM	04-6
<i>TOILET</i>	04-6
<i>DRAINING THE HOLDING TANKS</i>	04-7
<i>HOLDING TANK CARE</i>	04-9

ELECTRICAL SYSTEMS05-1

CHASSIS 12-VOLT ELECTRICAL SYSTEM.....	05-1
<i>CHASSIS BULBS AND FUSES</i>	05-1
12-VOLT COACH SYSTEM	05-2
<i>AUXILIARY START SYSTEM</i>	05-2
<i>BATTERY INSPECTION AND CARE</i>	05-3
<i>BATTERY CHARGING</i>	05-4
<i>SELECTING A REPLACEMENT BATTERY</i>	05-5
120-VOLT SYSTEM	05-5
<i>POWER CONVERTER</i>	05-5
<i>GROUND FAULT CIRCUIT INTERRUPTER</i>	05-5
COACH FUSES AND CIRCUIT BREAKERS.....	05-6
GENERATOR	05-7
<i>GENERATOR FUEL SUPPLY</i>	05-7
<i>GENERATOR OPERATION</i>	05-7
<i>GENERATOR OPERATING SAFETY PRECAUTIONS</i>	05-8
ELECTRICAL SYSTEM WIRING.....	05-9

LP GAS SYSTEM06-1

LP GAS SAFETY PRECAUTIONS.....	06-2
SYSTEM COMPONENTS	06-4
<i>HOSES</i>	06-4
<i>LP GAS REGULATOR</i>	06-4

Table of CONTENTS

Using LP GAS SYSTEM AT LOW TEMPERATURES	06-5
Filling LP GAS TANKS	06-6
LP GAS SYSTEM LEAK CHECKS	06-7
LP LEAK DETECTOR.....	06-8
Lighting LP GAS Appliances.....	06-9

Appliances07-1

WATER HEATER.....	07-1
REFRIGERATOR.....	07-2
<i>REFRIGERATOR DOOR PANELS</i>	07-2
FURNACE.....	07-2
RANGE	07-3
RANGE EXHAUST HOOD.....	07-4
DUCTED AIR CONDITIONER (<i>If Equipped</i>)	07-4
ENTERTAINMENT EQUIPMENT.....	07-5
<i>120-Volt TV AND VCR (If Equipped)</i>	07-5
<i>120/12-Volt Television (If Equipped)</i>	07-5
TV ANTENNA	07-5
TV AND RADIO INTERFERENCE	07-6
MISCELLANEOUS APPLIANCES	07-7

MAINTENANCE08-1

EXTERIOR	08-2
<i>STAINS</i>	08-2
<i>Windows, Doors, VENTS AND Locks</i>	08-3
RUBBER ROOF SYSTEM	08-3
<i>CLEANING</i>	08-3
<i>CARE</i>	08-3
<i>SEALANT RENEWAL</i>	08-4
<i>DOOR, Window, Roof COMPONENT</i>	

Table of CONTENTS

<i>and Molding RESEALING</i>	08-4
INTERIOR.....	08-2
<i>FABRICS</i>	08-5
<i>LAMINATE TOP CARE</i>	08-5
<i>WALLS AND CEILING PANELS</i>	08-5
<i>BATHUB AND PLASTIC SHOWER STALL</i>	08-6
<i>FLOORS AND CARPETING</i>	08-6
<i>ENGINE ACCESS</i>	08-6
MAINTENANCE CHECKLIST.....	08-6
MAINTENANCE CHART	08-7
STORAGE	09-1
STORAGE CHECKLISTS.....	09-1
<i>SHORT-TERM STORAGE</i>	09-1
<i>LONG-TERM STORAGE</i>	09-3
WINTERIZATION.....	09-5
<i>WATER SYSTEM WINTERIZING</i>	09-5
REACTIVATING THE MOTOR HOME AFTER STORAGE.....	09-8
GLOSSARY	10-1

INTRODUCTION

Welcome to the recreational vehicle life-style and the growing family of motor home owners. We sincerely thank you for choosing a Fleetwood motor home!

Your motor home has been designed to provide you with years of carefree, pleasant traveling and vacationing. It conforms with, or exceeds, applicable *American National Standards Institute (ANSI)*, *National Fire Protection Association (NFPA)*, *Canadian Standards Association (CSA)* (units built for Canada only), *Federal Motor Vehicle Safety Standards (FMVSS)* and *Environmental Protection Agency (EPA)* and *California Air Resources Board (CARB)* regulations. These standards and regulations establish the plumbing, heating, electrical and other requirements for safety. The seal attached just outside the entry door indicates compliance with *ANSI* or *CSA* standards.

Like all finely crafted equipment, your motor home will require care and regular maintenance in order to deliver maximum value and performance. The dealer will give you basic operating and maintenance instructions. However, supplement this by reading all instructional material furnished with the motor home in the *Owner's Information Package* and motor home *Chassis Operator's/Owner's Guide/Manual*. This information outlines important areas of operation and maintenance for you to follow for safe, trouble-free service from your motor home. Study these instructions carefully. A good working knowledge of your motor home and how to care for it will help you enjoy many miles and years of recreational living.



NOTE

This manual describes many features of your motor home and includes instructions for its safe use. This manual, including photographs and illustrations, is of a general nature only. Some equipment and features described or shown in this manual may be optional. Because of the continuous program of product improvement conducted by Fleetwood, it is possible that recent product changes may not be included. The instructions included in this manual are intended as a guide, and in no way extend the responsibilities of the manufacturing subsidiary, parent company or affiliates beyond the standard written warranty as presented in this manual.

INTRODUCTION

In this manual, statements preceded by the following words are of special significance:

WARNING

means that there is the possibility of personal injury to yourself and others.

CAUTION

means that there is the possibility of damage to the vehicle.

NOTE

indicates points of particular interest for more efficient and convenient operation.

Please pay close attention to these statements while you read this manual.

If you have any questions regarding operation, maintenance, or service, please contact your dealer immediately so he can assist you. Your dealer's Service or Sales Department will handle any normal problems which might occur.

NOTE

This product is designed for recreational use and short term occupancy only. It is not designed or intended to be used as permanent housing. Use of this product for long term or permanent occupancy may lead to premature deterioration of interior finishes, fabrics, carpeting, drapes, and appliances and fixtures. Damage or deterioration due to long term occupancy is not considered normal, and will under the terms of the warranty constitute misuse, abuse, or neglect, thereby reducing your warranty protection. Before considering this motor home for long term occupancy, consult the relevant sections in this manual.

Your motor home is covered by one of the most comprehensive warranty programs in the RV industry. Please refer to the warranty in the front of this manual. It explains your rights and obligations, as well as the rights and obligations of the dealer and manufacturer. Please read this section carefully. You will be better informed in case you have a warranty-related problem, and your dealer will be better able to get you on the road again. If you have any questions about the warranty or what it does or does not cover, please contact your dealer.

WARRANTIES

The materials in your *Owner's Information Package* contain warranty information and operating instructions on the various appliances and components in your motor home.

Warranty registration cards for these items should be filled out and mailed as soon as possible after you take delivery of your motor home. If you do not have operating instructions for a particular appliance, contact your dealer.

You will automatically receive an *Ownercare Card* approximately 3-4 weeks after delivery of your new motor home. This card is imprinted with your name, the motor home serial number, and manufacturing subsidiary location. If your motor home ever needs warranty service, present this card to the dealer, or have it available when contacting a Fleetwood Service Center.

The motor home has been thoroughly inspected before shipment. Your dealer is responsible for performing a complete predelivery inspection of the chassis and all motor home components as specified in the predelivery checklists supplied by the motor home and chassis manufacturers. You should receive a copy of these completed checklists from your dealer when your motor home is delivered to you.

As a part of the predelivery inspection procedure, the dealer is responsible for road testing the motor home, noting and correcting any steering problems before delivery.

Fleetwood and its subsidiaries will not be responsible for front end alignment after this predelivery inspection is done.

You should return your motor home to the selling dealer for warranty service. If this is not possible, you may contact any other authorized Fleetwood motor home dealer. The service department at any of the locations listed at the back of this manual can help you find a dealer in your area.

If you have a warranty or service concern about the chassis portion of your vehicle please be aware that you may go directly to an authorized chassis dealer for service. This may

INTRODUCTION

save you time and effort as the chassis warranty is administered by the chassis manufacturer. Consult your area phone directory for an authorized dealer and make arrangements with their service department. If you are unsure if the concern is chassis related, feel free to contact your Fleetwood dealer to assist you.

If, for some reason, a problem is not handled to your satisfaction:

1. Discuss any warranty-related problems directly with the manager and/or owner of the dealership, giving them an opportunity to help the service department resolve the matter for you.
2. If a problem arises that has not been resolved to your satisfaction by your local dealer, contact the Fleetwood Service Center. The locations are listed in the back of this manual. Please contact the one nearest you.
3. We sincerely believe that your dealer and the factory representative will be able to solve any problem which might arise. If their combined efforts are not satisfactory, please send a letter describing the circumstances to:

Fleetwood Enterprises, Inc.
Motor Home Division
PO Box 7638 Riverside, CA 92513-7638

Please include the brand name and serial number of your motor home. The serial number is located on the identification tag next to the entry door, and on your warranty card.

4. If you wish to call for assistance, please use this toll-free telephone number:

(800) 322-8216

There may be times when your motor home will need repairs or parts while you are on the road. If your motor home is repaired by a non-authorized repair facility (non-Fleetwood dealer), be sure to save receipts and especially any parts that are replaced. These parts will usually have to be returned to your dealer before you can be reimbursed for their cost.

Introduction

If you need service or warranty information, please see the booklets and other documents included in your *Owner's Information Package*. When contacting any of the equipment manufacturers, always have the model and serial numbers available. Appliance identification numbers will be found on tags or plates attached to the appliance.

If you ever need warranty work done, be sure to have the right papers with you. Take your warranty folder. If required work is not covered under the warranty, your dealer's service department can help you with getting the correct service. Always keep a maintenance log of your motor home's service history.

Always make a written list of the motor home's problems or the specific work you want done. If you've had work done that is not on your maintenance log, especially while out of town, let the service advisor know. Don't keep secrets.

And finally, be reasonable with requests. If you have a long list of service items that need attention and you need your motor home very soon, discuss the situation with the service advisor, listing the items in order of priority. This will help the service department manage their time and will help get you going as quickly as possible.

SUGGESTIONS FOR OBTAINING SERVICE FOR YOUR MOTOR HOME

If you need service or warranty information, please see the booklets and other documents included in your *Owner's Information Package*. When contacting any of the equipment manufacturers, always have the model and serial numbers available. Appliance identification numbers will be found on tags or plates attached to the appliance.

WARRANTY SERVICE

Chassis component (engine, transmission, axles, etc.) identification numbers will be located in the manuals included with your motor home.

If you need service or warranty information, the following phone numbers may be helpful:

<i>Refrigerator (Dometic)</i>	(800) 544-4881
<i>Range</i>	(800) 332-4432
<i>Water Heater (Atwood)</i>	(800) 847-7160
<i>Air Conditioner (RVP)</i>	(800) 227-5693
<i>Furnace (HydroFlame)</i>	(800) 825-4328
<i>Generator/Power Plant (Onan)</i>	(800) 222-4871
<i>Entry Step (Kwikkee)</i>	(800) 736-9961
<i>Awning (A&E/Dometic)</i>	(800) 544-4881

If you believe that your vehicle has a defect which could cause a crash or could cause injury or death, you should immediately inform the *National Highway Traffic Safety Administration (NHTSA)* in addition to notifying the Fleetwood Service Center at 1-800-322-8216.

If *NHTSA* receives similar complaints, it may open an investigation, and if it finds that a safety defect exists in a group of vehicles, it may order a recall and remedy campaign. However, *NHTSA* cannot become involved in individual problems between you, your dealer or Fleetwood's manufacturing subsidiary.

To contact *NHTSA*, you may either call the Auto Safety Hotline toll-free at 1-800-424-9393 (or 366-0123 in Washington, D.C.) or write to:

NHTSA
U.S. Department of Transportation
400 Seventh St. SW
Washington, DC 20590

You can also obtain other information about motor vehicle safety from the Hotline.

This package contains valuable documents about your motor home and its equipment and systems. This *Owner's Manual* is in the package. Since this manual does not cover every possible detail of equipment and options installed on or in your motor home, there are booklets and instructional material in the package that will help you safely operate, maintain and troubleshoot those items. Be sure you read all this information and understand the safety and operating instructions included in the package. Additionally, you must follow all maintenance instructions to insure full warranty coverage. If you ever decide to sell or trade your motor home, be sure the new owner receives all the material in this package.

REPORTING SAFETY DEFECTS

OWNER'S INFORMATION PACKAGE

Introduction

Several numbers are used to identify the vehicle and components used on the vehicle.

The **V.I.N.** or *Vehicle Identification Number* is the identification of the completed vehicle and is the number of the vehicle registration. The V.I.N. can be found in three places: the Federal Certification Tag located on the left interior stepwell in the driver's compartment; on the driver's door; and on the top of the instrument panel on the driver's side. Refer to this information when ordering parts from the chassis manufacturer or chassis dealer service center.

The **F.I.N.** or *Fleetwood Identification Number* is located on the tag just outside the main entry door or on the outside left front side of the motor home. Use this number when ordering parts through your Fleetwood dealer or Service Center.

(sample)

FEDERAL CERTIFICATION TAG		
MFG BY:	DATE OF MFR:	
INCOMPLETE VEHICLE MFG. BY:	DATE OF INC. VEH. MFR:	
GVWR:	KGS (LBS)
GAWR FRONT:	KGS (LBS)
	WITH:	RIMS
	TIRES AT:	KPA COLD SINGLE
	(PSI)
GAWR INTERMEDIATE:	KGS (LBS)
	WITH:	RIMS
	TIRES AT:	KPA COLD DUAL
	(PSI)
GAWR REAR:	KGS (LBS)
	WITH:	RIMS
	TIRES AT:	KPA COLD SINGLE
	(PSI)
GAWR COMBINED INTERMEDIATE AND REAR:	KGS (LBS)
This vehicle conforms to all applicable U.S. Federal Motor Vehicle Safety Standards in effect on:		
V.I.N. _____		
TYPE VEHICLE: MULTI-PURPOSE PASSENGER VEHICLE		
The tires on this unit may be different from those shown above. Check tire sidewalls for maximum inflation pressure. Replacement tires must be rated no less than the axle capacity (GAWR).		
W15-0002		

Located on the left interior stepwell of the motor home driver compartment.

CHASSIS AND VEHICLE IDENTIFICATION

(sample)

FLEETWOOD®	
MOTOR HOMES	
OF	INC.
PLAN APPROVAL NO.	
F.I.N.	
MFD. ID. NO.	MODEL
DATE OF MFR. MO:	YR:

Located on the left of the main entry door or on exterior left front side of the motor home.

F.I.N. (Fleetwood Identification No.)

V.I.N. (Vehicle Identification No.)

VEHICLE IDENTIFICATION NUMBER

BAR CODE

This tag is located on the left top of the instrument panel.

SUSPENSION ALIGNMENT AND TIRE BALANCE

The front suspension and steering system of this vehicle was accurately aligned at the factory before delivery to the dealership. However, after you have fully loaded the vehicle according to your personal needs, have the alignment checked and adjusted, if necessary. To help prevent uneven tire wear, check the front-end alignment periodically.

Please note that front-end alignment after retail delivery is the owner's responsibility and is not covered under the warranty.

Excessive or abnormal tire wear may indicate worn or misaligned suspension or steering components, unbalanced tire(s) or some other tire/suspension problem.

Alignment can be affected by worn steering/suspension parts or road hazards such as hitting a curb, pothole, railroad track, etc. Improper alignment can cause tires to roll at an angle and wear unevenly. It may also cause the vehicle to "pull" to the right or left.

Out-of-balance tires will not roll smoothly and will cause annoying vibrations and uneven tread wear such as cupping or flat spots. If you see uneven tire tread wear or if the vehicle ride comfort decreases, the tires may need to be balanced.

See the *Chassis Operator's/Owner's Guide/Manual* for more information.

Fleetwood does not sanction or condone the installation of any steering aid device that is not approved by our chassis manufacturer's. Any add-on device of this type will likely void the chassis manufacturer's warranty on the item or items affected.

AFTER-MARKET STEERING AID DEVICES

Any after-market steering aid device proposed for installation must be approved by *Fleetwood Motor Home Product Engineering* before considering it for any after-market installation on your motor home.

INTRODUCTION

WARNINGS, TERMS AND CONCEPTS FOR SAFE OPERATION OF YOUR MOTOR HOME

Vehicle Crash

Like any other vehicle you may drive, your motor home can be involved in a vehicle crash, including a rollover. The motor home will be damaged and you and others can be injured or killed. Drive defensively at all times. **DO NOT** drive if you are tired, have been drinking alcoholic beverages, are under the influence of any controlled substance, or are taking any medication or drugs that may impair your sight, hearing, judgment or coordination. Pull off the road and park in a safe area until you can drive safely.

Vehicle Handling

Your motor home is longer, wider and higher than a typical car or truck you may be accustomed to driving. Keep this in mind as you become familiar with driving your motor home. New motor home owners should take special care to learn the driving and handling characteristics of your vehicle in safe and familiar surroundings. The distribution of the weight of your motor home is designed so it will handle safely while being driven.

- » *When loading the motor home, balance the load front-to-rear and side-to-side.*
- » *Load and secure heavier items lower in the storage areas than lighter items.*

If you fail to properly load your belongings and supplies, you will defeat the load distribution design of the motor home, possibly leading to handling problems and a vehicle crash.

Vehicle Response

When you, the driver, accelerate, brake or steer the motor home, it responds to these inputs. If you are faced with an emergency while driving, the way you respond to the emergency and the way the motor home responds becomes more critical. If you load, alter or maintain your motor home improperly, it will not respond as it did when you first received it in an unloaded condition.

Improper loading, alteration, maintenance and improper driver responses to emergency conditions can lead to handling problems and vehicle crashes.

Vehicle Towing

Your motor home can be equipped with a hitch designed to allow you to tow vehicles or other loads behind your motor home. The maximum amount of weight your motor home can pull or stop is determined by the manufacturer of the chassis on which your motor home is built. Check the ***Chassis Operator's/Owner's Guide/Manual*** provided by the motor home chassis manufacturer for the limits on the weight you can tow.

If the ***Chassis Operator's/Owner's Guide/Manual*** does not provide information on towing weight limits, do not tow a load of more than 1000 pounds unless the towed unit has a properly installed and operating supplemental brake control system that operates with the brakes on your motor home.

- » You may be able to increase the weight of any towed load by properly installing on the towed load a supplemental brake control system that operates with your motor home's braking system. Even with additional brakes, you cannot tow more than the GTW or GCWR for the chassis under your motor home. Again, check the ***Chassis Operator's/Owner's Guide/Manual***.
- » You **CANNOT** increase the towed weight limit by changing the size of your hitch.

INTRODUCTION

- » Properly load what you tow to avoid a vehicle crash.
- » **Do not** attempt to tow something that is too heavy for your chassis.
- » **When driving in mountainous areas, look for and obey highway signs concerning grades and curves.** Your driving experience when pulling and stopping a towed unit on mountain roads will be very different from what you experience on level ground.
- » State laws in the United States and provincial laws in Canada are different concerning towing requirements and limits. Check the laws in the areas where you anticipate traveling.

Alterations to Your Motor Home

Many motor home owners like to add a personal touch to their motor home. But there is a difference between changing how your motor home looks versus how it handles or responds to driver inputs. If you expect to make any type of alteration to your motor home, consult a professional who understands the correct way to do the alteration and how the alteration will change or affect the stability, handling, vehicle response, and overall performance and safety of your motor home. ***An improper alteration that affects vehicle handling or response can cause a vehicle crash, and any improper alteration to the electrical or LP gas systems can cause a fire and can endanger your motor home and its occupants.*** Fleetwood and your chassis manufacturer stand behind the motor home as delivered - **NOT** as altered by someone else.

Maintenance

It is your responsibility to properly maintain your motor home. Consult your Fleetwood and *Chassis Operator's/Owner's Guide/Manual* for service information. See an authorized Fleetwood dealer to have your motor home serviced or repaired. You, or an experienced professional, should check all fluid levels and change fluids and filters when needed. Tire condition and proper inflation pressure is critical to safe operation. Keep your vehicle properly maintained to help avoid a vehicle crash.

Warning Devices

Your motor home is equipped with warning devices. Check them before a trip for proper operation. A disabled warning device cannot warn you or your occupants of a life-threatening danger. Keep them working and respond to them quickly.

This page intentionally blank.

ON THE ROAD

MOTOR HOME LOADING

RESPONSIBILITY FOR PROPER LOADING

As the operator of this motor home, you are responsible for its proper and safe loading. This section is intended to provide you with helpful information concerning the loading of your motor home.

Your motor home chassis is designed to carry a specific maximum weight. This weight includes everything: the weight of the empty motor home itself, all occupants and their belongings, fuel, fresh water, waste water and anything else that may be in or attached to the motor home. *This weight must never be exceeded.* If you do exceed this weight, you will change how your motor home handles and responds, possibly leading to a vehicle crash.

Before discussing loading and weighing, we need to explain some common weight terms. We will use abbreviations and you should refer back to these terms if you do not understand what the abbreviation means.

SOME DEFINITIONS FIRST

GVWR (Gross Vehicle Weight Rating)*

means the maximum permissible weight of this motor home. The GVWR is equal to or greater than the sum of the Unloaded Vehicle Weight plus the Net Carrying Capacity.

GCWR (Gross Combined Weight Rating)*

means the value specified by the motor home manufacturer as the maximum allowable loaded weight of this motor home with its towed trailer or towed vehicle. Towing and braking capacities may be different. Refer to Fleetwood and the chassis manufacturer's manuals for complete information.

***These ratings are shown on the Carrying Capacity label.**

ON THE ROAD

GTW (Gross Towed Weight)*

means the maximum permissible loaded weight of a trailer or car that this motor home has been designed to tow. This cannot be increased by changing the trailer hitch.

GAWR (Gross Axle Weight Rating)*

means the maximum permissible loaded weight a specific axle is designed to carry.

TW (Tongue Weight)*

the maximum permissible downward force exerted on the hitch ball by the towed vehicle coupler.

UVW (Unloaded Vehicle Weight)*

means the weight of this motor home as built at the factory with full fuel, engine oil and coolants. The UVW does not include cargo, fresh water, LP gas, occupants, or dealer installed accessories.

NCC (Net Carrying Capacity)*

means the maximum weight of all occupants including the driver, personal belongings, food, fresh water, LP gas, tools, tongue weight of towed vehicle, dealer installed accessories, etc., that can be carried by this motor home. Normal variation of materials may cause the Net Carrying Capacity to be 200 lbs. higher or lower than stated. (NCC is equal to or less than GVWR minus UVW.)

Designated Seating Capacity (Canadian units only)

the number of sleeping positions designated equals the seating capacity.

When you use your motor home to tow, remember that you must stop the towed load with your motor home's brakes. This is critical on hills and in the mountains where you may encounter sharp curves and possibly irregular road surfaces. Check your motor home *Chassis Operator's/Owner's Guide/Manual* for the maximum weight your motor home can pull and stop on both level and steep roads. If the *Chassis Operator's/Owner's Guide/Manual* does not provide information on towing weight limits, do not tow a load of more than 1000 pounds unless the towed unit has a properly installed and operating supplement brake control system that operates with the brakes on your motor home. The supplemental brakes will NOT allow you to tow more than the listed GCWR for your motor home. *If you cannot stop, you will crash.*

You must not exceed the weight factors listed below if you expect to tow something behind your motor home, either with or without a dolly. The factors are:

- » *GCWR - Gross Combined Weight Rating*
- » *GTW - Gross Towed Weight*
- » *TW - Tongue Weight*
- » *GAWR - Gross Axle Weight Rating*

The ratings for these factors are all listed on the carrying capacity label posted inside the motor home.

TOWING A VEHICLE OR TRAILER

(*"TOWED LOAD OR
TOWED UNIT"*)



NOTE

Some states and provinces require brakes and safety chains on towed vehicles. Consult the proper authorities in the states or provinces through which you will be traveling.

ON THE ROAD

If you expect to tow with your motor home, there are additional guidelines that you must follow:

- » ***Do not use a load equalizing hitch. It could cause structural damage to the motor home frame components.***
- » ***Limit the tongue weight to the Towed Weight as listed on the carrying capacity label. Heavier tongue weights can change your vehicle's handling and response, can cause a vehicle to crash, and will restrict your coverage under the Ownercare Warranty.***
- » ***Do not tow anything weighing more than the GTW listed on the carrying capacity label. Heavier towed loads can exceed your chassis' ability to pull and stop the load and cause a vehicle crash, damage the motor home structure or drive train, and restrict your coverage under the Fleetwood or chassis manufacturer's warranty. Changing the trailer hitch will not increase the tow capacity of the motor home.***
- » ***Consult the Chassis Operator's/Owner's Guide/ Manual, and U.S. state and Canadian provincial laws for towing weight limits and for guidelines for installing supplemental braking systems that operate with your motor home's brakes.***

The way your motor home handles and responds will be affected by the way the towed unit is loaded. If the tongue weight is too light in relation to the GTW, handling and response will change and your motor home will operate less safely. Careful load planning and safe experimentation with different loading patterns in what you are towing can avoid this risk and make your driving and towing experience safer and more enjoyable.

	WARNING
Do not exceed the rated load of the motor home, or the rated load of any axle. Exceeding the GVWR, GAWR, GTW or GCWR of your motor home can cause handling problems, a vehicle crash, damage your motor home and void your warranties.	

The amount of cargo weight you can place in your motor home is the motor home's GVWR *minus* its UVW, or maximum capacity *minus* the weight of your motor home as assembled by Fleetwood, *i.e.*, without dealer installed accessories, water, LP gas, cargo or occupants. When the motor home is being designed, the number and size of storage compartments, the liquid tank capacities and number of belted seating positions are determined for value and convenience. If you fill all liquid tanks to capacity, fill all storage compartments and cupboards to maximum volume and fill all available seating positions with passengers, the motor home could be overloaded. (See **Loading Tips**). Be aware of the weight of the items you store and where you store the items in your motor home, and weigh your motor home after it is fully loaded.

In addition to knowing the overall weight that can be safely loaded in or attached to the motor home, you must know how to distribute the weight so that correct amounts of weight are distributed between the axles or front-to-rear and also between the wheels or side-to-side. It is also important to place heavier items in under-the-floor storage or low in the motor home. If you make the motor home top heavy or much too heavy on one side, the motor home can be overturned and crash in a curve, turn or in an emergency steering maneuver. When the load is properly distributed, your motor home will handle and respond safely, and you as the driver can be more confident and will be more comfortable.

If your motor home is improperly loaded, it may be unsafe to drive, uncomfortable to drive, or both. Axle load is important and it is recommended that you should load your motor home so that the front axle is loaded to at least 80% of the front GAWR.

CARRYING CAPACITY AND LOAD DISTRIBUTION



NOTE

Net Carrying Capacities (NCC) of your motor home are specified on a label affixed to the inside of the motor home. The label includes all factory installed options. If other equipment such as leveling jacks, awnings, roof pods, etc., are installed after the motor home leaves the factory the weight of these items must be subtracted from the total of the passenger and cargo carrying capacities.

CARRYING CAPACITY

PRODUCT	YEAR	MODEL	SERIAL NO.
GVWR			LBS.
GCWR			LBS.
FRONT GAWR			LBS.
REAR GAWR (Includes capacity of tag axle if so equipped.)			LBS.
HITCH RATING	LBS.	TONGUE WEIGHT	LBS. GTW LBS.
UVW (DRY WEIGHT) OF FINISHED VEHICLE			LBS.
NET CARRYING CAPACITY			LBS.

GVWR (Gross Vehicle Weight Rating): means the maximum permissible weight of this motor home. The GVWR is equal to or greater than the sum of the Unloaded Vehicle Weight plus the Net Carrying Capacity.

GCWR (Gross Combination Weight Rating): means the value specified by the motor home manufacturer as the maximum allowable loaded weight of this motor home with its towed trailer or towed vehicle. Towing and braking capacities may be different. Refer to Fleetwood and the chassis manufacturer's manual for complete information.

GAWR (Gross Axle Weight Rating): means the maximum permissible loaded weight a specific axle is designed to carry.

GTW (Gross Towed Weight): means the maximum permissible loaded weight of a trailer or car that this motor home has been designed to tow. This cannot be increased by changing the trailer hitch.

Tongue Weight: The maximum permissible downward force exerted on the hitch ball by the towed vehicle coupler.

UVW (Unloaded Vehicle Weight): means the weight of this motor home as built at the factory with full fuel, engine oil, and coolants. The UVW does not include cargo, fresh water, LP gas, occupants or dealer installed accessories.

NCC (Net Carrying Capacity): means the maximum weight of all occupants including the driver, personal belongings, food, fresh water, LP gas, tools, tongue weight of towed vehicle, dealer installed accessories, etc., that can be carried by this motor home. Normal variation of materials may cause the Net Carrying Capacity to be 200 lbs. higher or lower than stated. (NCC is equal to or less than GVWR minus UVW.)

This motor home is capable of carrying up to _____ gallons of fresh water (including water heater) for a total of _____ pounds.

Reference: Weight of fresh water is 8.33 lbs./gal.; Weight of LP gas is 4.5 lbs./gal. (average).

WARNING: The Heaviest Loaded Motor Home With All Passengers, Goods, Water, Driver And Towed Vehicle Must Not Exceed Any Of The Following:

1. The gross vehicle weight rating (GVWR).
2. The gross combination weight rating (GCWR).
3. The front/rear gross axle weight ratings (GAWR'S).

CONSULT OWNER'S MANUAL FOR WEIGHING INSTRUCTIONS AND TOWING GUIDELINES.

W15-2013 10/95

Carrying Capacity Label

Refer to your local telephone directory to find a public weigh station. The following procedures will help you determine whether your loaded motor home (complete with cargo, fluids, passengers, and driver) is within GAWR, GVWR, and GCWR limits. When you arrive at a weigh station, the attendant will guide you through the correct positioning of the motor home on the scales.

1. Center the front wheels on the scale platform and take a reading. This is the front Gross Axle Weight (Reading 1).

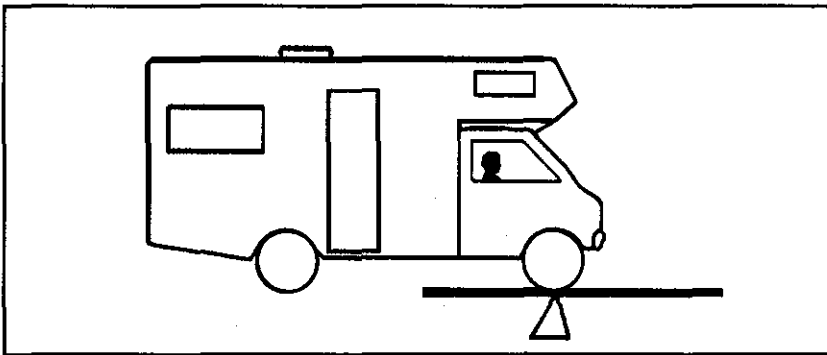

2. Center the entire motor home (all axles) on the scale and take a reading. This is the Gross Vehicle Weight (Reading 2).

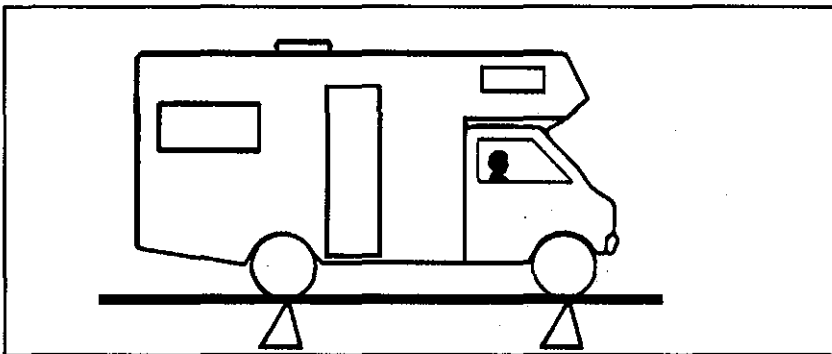

HOW TO WEIGH YOUR LOADED MOTOR HOME WITHOUT A TRAILER OR OTHER TOWED LOAD

ON THE ROAD

- Center the rear axle on the platform and take a reading. This reading is the rear Gross Axle Weight (Reading 3).

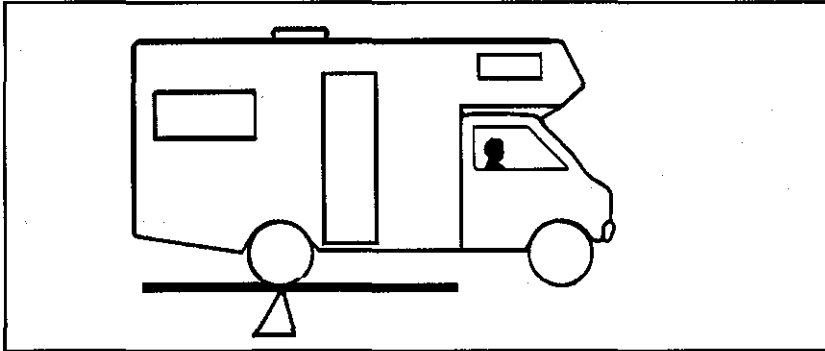

Compare the readings taken on the scales to the weight ratings on the Federal certification tag and wardrobe door tag. Fill in the chart at the back of this manual to aid in comparing weights.

If any readings are higher than the rating, you will have to adjust or remove the load..

MOTOR HOME READINGS (from tags)		SCALE READINGS
GVWR _____	MOTOR HOME	Reading 2 _____
Front GAWR _____	FRONT AXLE	Reading 1 _____
Rear GAWR _____	REAR AXLE	Reading 3 _____
Hitch Rating _____	TOWED VEHICLE	Reading 4 _____
GCWR _____	COMBINED VEHICLES	Add 2 and 4 _____

1. Center the front wheels on the scale platform and take a reading. This is the front Gross Axle Weight (Reading 1).

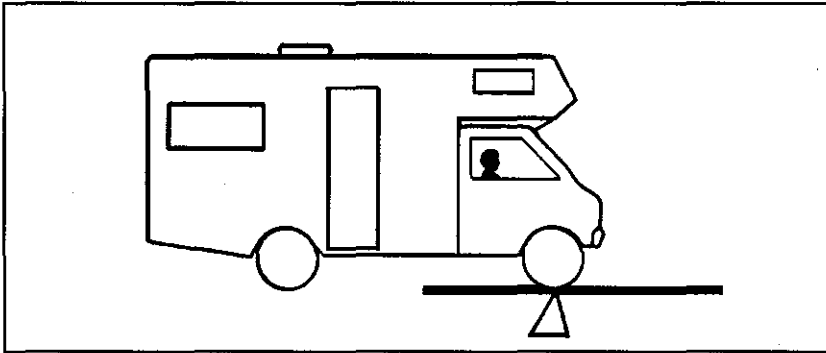

2. Center the entire motor home so that only the motor home is being weighed. Leave the towed load hitched to the motor home, but resting off of the scale. This is the Gross Vehicle Weight (Reading 2).

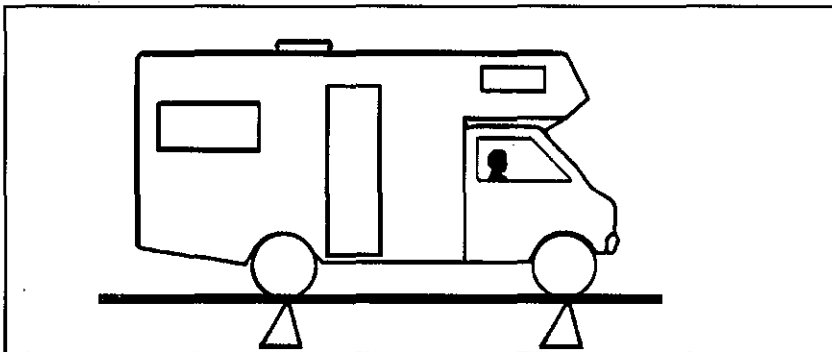

3. Center the towed load on the scale and take a reading. This is the Towed Vehicle Weight (Reading 4).

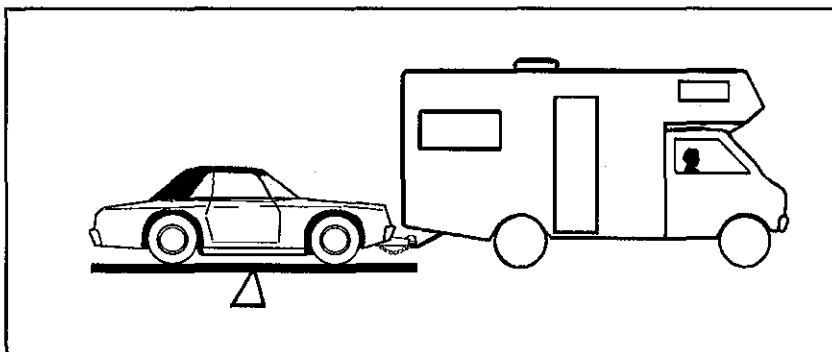

HOW TO WEIGH YOUR LOADED MOTOR HOME WITH A TRAILER OR OTHER TOWED LOAD

ON THE ROAD

4. Subtract Reading 1 from Reading 2. This is the rear Gross Axle Weight (Reading 3).

Compare the readings taken on the scales to the weight ratings on the Federal certification tag and carrying capacity label. Fill in the chart to aid in comparing weights.

If any readings are higher than the rating, you will have to adjust or remove the load.

If you exceed weight ratings, you will:

- » ***Cause unsafe braking.***
- » ***Cause unstable driving and handling characteristics.***
- » ***Cause damage to the motor home, drive train, or chassis.***
- » ***Reduce your warranty protection.***

Since you may load your motor home differently for different trips, loading and weight patterns will change.

Periodically reweigh your motor home and log the weights in this chapter. Refer to your log as you prepare to load for future trips.

LOADING TIPS

- » *Load heavier items lower.*
- » *Do not load heavy items on the bumpers.*
- » *Make a loading diagram of your properly loaded motor home, and then weigh the properly loaded motor home. The loading diagram, your loading log and the loaded motor home weight will help you locate where specific items are stored, and will help speed the loading process.*
- » *Secure and brace items so they won't move during travel.*
- » *Fresh water and waste water weigh over eight pounds per gallon. Carry only as much water as needed for travel use or to balance the load, and whenever practical, empty the holding tanks before traveling.*
- » *Store emergency items in a readily accessible location. As a minimum include a fire extinguisher, tools, first aid kit, rain gear, flashlight, highway warning devices, an electric cord with light, and sturdy gloves.*

 **WARNING**

Modification of your vehicle by addition of racks not originally equipped by the manufacturer to carry additional equipment, vehicles or cargo will reduce your warranty coverage and may cause personal injury or property damage.

 **WARNING**

Do not store or carry LP gas containers, gasoline, or other flammable liquids inside your motor home.

ON THE ROAD

Your motor home is equipped with wheels and tires selected to match the capacity specifications of the chassis as designed by the chassis manufacturer. Under normal circumstances and with proper tire and chassis maintenance, you should receive thousands of miles of trouble-free service.

TIRES

For safety and maximum tire life, vehicle speeds must be proper, proper inflation pressure must be maintained, and tread depth and wear must be monitored. Properly inflated tires also contribute to overall motor home stability and safety. Refer to the tire section in your *Chassis Operator's/Owner's Guide/Manual* or any tire manufacturer's information that may be provided in your *Owner's Information Package* for information on maintenance and tire care.

The maximum inflation pressures are stated on the Federal Certification Tag located on the sidewall near the driver's seat. To maximize tire performance, consult with the tire manufacturer's guidelines or *Chassis Operator's/Owner's Guide/Manual* for recommended tire inflation pressure.

TIRE INFLATION

WARNING

For safety and maximum tire life, check tire pressures often (including the spare, if equipped). Pay special attention to inside rear duals. Always check pressure when tires are cold, and do not bleed air out of warm tires. Follow the tire pressure instructions in the *Chassis Operator's/Owner's Guide/Manual* or the tire manufacturer's information.

NOTE

The tire pressures on your motor home were adjusted for the weight of the motor home at the time it was built. These pressures may be lower than the pressures required for the weight of a loaded motor home. Check and adjust the tire pressures on your motor home before your first trip using the information provided in the *Chassis Operator's/Owner's Guide/Manual*.

NOTE

Check the wheel lug nut tightness periodically. They could work loose during driving. Check the *Chassis Operator's/Owner's Guide/Manual* for correct lug nut torque and torquing procedure.

TIRE REPLACEMENT

Replacement tires must be the same size, type and tread depth per axle, and have at least the same weight carrying capacity as the original equipment. All tires of the same size and rating may not have the same weight carrying capacity. Consult your tire dealer. The original equipment wheels and tires supplied on your motor home have weight carrying capacities to support Gross Axle Weight Ratings (GAWR) as stated on the Federal Certification Tag located on the side-wall near the driver's seat.

In case of sudden tire failure:

IF YOU GET A FLAT TIRE

- » *Remove your foot from the accelerator.*
- » *Use moderately heavy brake pedal pressure. Do not pump the brake. The vehicle is equipped with Anti-lock Brakes (ABS) which will properly control braking.*
- » *Firmly hold the steering wheel while avoiding abrupt steering inputs and move slowly to a safe, off-road place.*
- » *Park on a firm level surface.*
- » *Turn off the ignition.*
- » *Set the parking brake.*
- » *Turn on the hazard flasher system.*
- » *Ensure your passengers are safely located and children monitored.*
- » *Get professional help.*

ON THE ROAD

On some models, the spare tire carrier is located under the rear of the motor home between the frame rails.

SPARE TIRE CARRIER



WARNING

Truck tires and wheels are extremely heavy and may weigh 100 pounds or more. Do not attempt to remove the spare tire unless you are capable of handling the weight.

Even with good tire maintenance and normal driving, you may experience a flat tire. Summon professional help through your auto club, travel service, or a local truck service facility. Your motor home is not equipped with a jack or other lifting device. Do not attempt to lift the motor home with a jack. Consult the *Chassis Operator's/Owner's Guide/ Manual* for additional information on tire inflation and proper torque.

CHANGING A FLAT TIRE



WARNING

Truck wheels and tires are extremely heavy and may weigh 100 pounds or more. Do not attempt to remove the spare tire unless you are capable of handling the weight.



WARNING

To avoid personal injury and/or property damage if a blowout or other tire damage occurs, obtain expert tire service help. Do not attempt to change the tire yourself.

Seat belts help to restrain you and your passengers in case of a collision. In most states, the law requires their use.

Seat belts provide the best restraint when:

- » *the seat back is upright*
- » *the occupant is sitting upright (not slouching)*
- » *the lap belt is snug and low on the hips*
- » *the shoulder belt is snug against the chest*
- » *the knees are straight forward*

For your safety, your vehicle has combination lap and shoulder belts for the driver and front seat passenger and lap belts without retractors in all other designated seating positions.

Always drive and ride with your seatback upright and the lap belt snug and low across the hips to reduce the risk of serious injury to the abdomen or neck that could be caused by sliding under the safety belts in a collision.

Never let a passenger hold a child on his or her lap while the vehicle is moving. The passenger cannot protect the child from injury in a collision.

Children should always ride with the seatback in the fully upright position. When the seatback is not fully upright, there is a greater risk that the child will slide under the safety belt and be seriously injured in a collision.

Never use a single belt for more than one person or across more than one seating position. This greatly increases the risk that one or both of the people will be injured in a collision. Each designated seating position in your vehicle has a specific seat belt assembly which is made up of one buckle and one tongue that are designed to be used as a pair.

SEATS AND SEAT BELTS

 **WARNING**

Make sure that you and your passengers, including pregnant women, wear safety belts. Be sure that lap belts fit snugly and as low as possible around the hips. If safety belts are not used properly, the risk of you or your passengers being injured in a collision greatly increases.

 **WARNING**

Use the shoulder belt on the outside shoulder only. Never wear the shoulder belt under the arm. Never swing it around the neck over the inside shoulder. Failure to follow these precautions could increase the risk and/or severity of injury in an accident.

ON THE ROAD

While your vehicle is in motion, the combination lap and shoulder belt adjusts to your movement. However, if you brake hard, corner hard or if your vehicle receives an impact, the lap and shoulder belt locks and prevents you from moving.

To fasten the belt, pull the lap/shoulder belt from the extractor so that the shoulder portion of the belt crosses your shoulder and chest. Insert the belt tongue into the proper buckle until you hear a snap and feel it latch.

To tighten the lap portion of the belt, pull up on the shoulder belt until it fits you snugly. The belt should rest as low on your hips as possible.

A longer lap and shoulder belt assembly is available and is a direct replacement for the driver and front passenger positions. The longer lap and shoulder belt is made and tested to the same standards as the original belt. This belt assembly can be purchased and installed at any authorized Fleetwood motor home dealer.

Check your safety belt system periodically to make sure that it works properly and isn't damaged. If the webbing shows any wear, nicks or cuts, have it examined by a qualified technician to determine if replacement is necessary. Always have your safety belt system checked after a collision.

COMBINATION LAP AND SHOULDER BELTS

SAFETY BELT MAINTENANCE

In most states, you are required by law to use safety restraints for children. If small children (less than four years old, and under 40 pounds) ride in your vehicle, you must put them in safety seats that are made specially for children. Safety belts alone do not provide maximum protection for these children. Check your local and state laws for specific requirements.

SAFETY RESTRAINTS FOR CHILDREN

	WARNING
Never leave a child unattended in your vehicle. Always remove the key from the ignition and take it with you.	

Safety belts and seats can become hot in a vehicle that has been closed up in sunny weather, and could burn a small child. Check seat covers and buckles before you place a child anywhere near them.

Children who are too large for child safety seats should always wear safety belts.

If the shoulder belt cannot be properly positioned so that it does not cross or rest in front of the child's face or neck, move the child to one of the seats with a lap belt only and use the lap belt.

Lap belts and the lap portion of lap and shoulder belts should always be worn snugly and below the hips, touching the child's thighs.

Children should always ride with the seatback in the fully upright position. When the seatback is not fully upright, there is a greater risk that the child will slide under the safety belt and be seriously injured in a collision.

Use a safety seat that is recommended for the size and weight of the child. Seat backs should be upright for use with child safety seats.

SAFETY BELTS FOR CHILDREN

 **WARNING**

If safety belts are not properly worn and adjusted as described, the risk of serious injury to the child in a collision will be much greater.

SAFETY SEATS FOR CHILDREN

 **WARNING**

Carefully follow all of the manufacturer's instructions that come with the safety seat that you put in your vehicle. Make sure that the shoulder belt (if provided at the seating position where the safety seat is being used) does not cross or rest in front of the child's face or neck. If you do not install and use the safety seat properly, the child may be injured in a sudden stop or collision.

 **WARNING**

When using any infant or child restraint system, it is important that you follow the instructions and warnings provided by the manufacturer concerning its installation and use. Failure to follow the restraint manufacturer's instructions could increase the risk or severity of an injury in the event of a collision or sudden stop.

ON THE ROAD

Driving your motor home will be different from driving your family car or truck. Your motor home is large and heavy. You may have to adjust or learn new driving techniques to safely operate your motor home.

Downhill driving puts extra strain on many drivetrain components of your motor home. The brakes are easily overloaded and overheated when used for downhill slowing. Brake fade will occur if the brakes overheat.

When driving down long grades, shift the transmission to a lower gear at the top of the grade. Rule of thumb: *Use the same lowest gear going down as it took to go up the hill.* Crest the hill in the lower gear. Monitor your speed.

Be cautious when maneuvering to allow for the length and width of the vehicle. Always allow room to corner and to change lanes. Your vehicle's side view mirrors and rear view camera monitor (if equipped) will help you keep aware of your vehicle's position and the position of other vehicles and/or obstructions near your motor home. You must monitor them constantly while you are driving. Become familiar with the operation of the side mirrors and learn to use them to view objects and the road beside and behind the motor home.

Remember that your motor home is heavier than a car, making it less maneuverable and harder to stop. Also, because of its greater side surface area, it is more easily affected by cross winds. Allow extra distances for passing and stopping, and drive at a moderate speed, particularly in traffic and in gusty wind conditions.

DRIVING AND VEHICLE CONTROL

MANEUVERING IN TRAFFIC



NOTE

Although your motor home is equipped with power steering, the front wheels may be difficult to turn when at a dead stop. When maneuvering in some close situations, give yourself some room to move either forward or backward. The vehicle has to be in motion for the front wheels to be turned with ease.

Driving on winding or mountain roads is not difficult if done with reasonable care. Observe proper vehicle speeds when ascending or descending hills and always operate in the proper transmission range. Downshift on hills to avoid overheating or undue engine loads. Downshift when descending grades.

Engine compression and friction will help control vehicle speed, and relieve some of the strain on the brakes. Shift the transmission to a lower gear before starting down the grade.

Mountain driving or desert temperatures can put extreme demands on drive train components. Under extreme heat conditions you may need to turn off the vehicle air conditioner to improve engine and transmission cooling.

Be aware of the extra height of your motor home. Check for low hanging tree branches or other obstructions whenever you drive or park. Avoid low overhangs when pulling in for service. Always check overhead clearances of overpasses and bridges. ***This may be particularly important if you drive with the overhead vents open or if the motor home is equipped with a roof air conditioner, roof rack, CB or TV/radio/satellite antenna.***

Before leaving on a trip, check your route. Some tunnels prohibit motor homes with LP gas systems.

When parking parallel to a curb, be sure to allow for poles or obstructions as the front and rear portions of the motor home swing wider than an automobile. When parking on an incline, turn the front wheels into the curb in the direction of the roll to aid the parking brake. When parking, always shift the transmission to P and set the parking brake.

ON THE ROAD

If you can't avoid operating, parking or idling your vehicle off-road:

- » *Be aware that combustible materials could catch fire from the vehicle's hot exhaust system.*
- » *Avoid driving your vehicle through or over combustible materials such as leaves, grass, vegetation or stubble high enough to touch, catch or collect on its hot exhaust system.*
- » *Parking or idling should be done only in an area where there are no combustible materials under the vehicle.*

	WARNING
Do not park or idle the motor home over combustible materials such as tall grass or dried leaves. Combustible materials may catch fire from the hot exhaust gases, soot or sparks that could escape through corrosion holes or cracks. This is particularly important if the exhaust system has not been properly maintained.	

To use the engine as a braking force, select the next lower gear. Engine braking provides good speed control for going down grades. When the motor home is heavily loaded, or the grade is steep, preselection of a lower gear prior to the grade may be desirable.

Gear preselection means the selection of a lower gear to match the driving conditions you encounter or expect to encounter. Preselection will give you better control on slick or icy roads and on downgrades. Downshifting to lower gears increases engine braking. The selection of a lower gear often prevents cycling between a gear and the next higher gear on a series of short up-and-down hills.

USING THE ENGINE TO SLOW THE MOTOR HOME

BODY UNDERCOATING

In keeping with good engineering practice, and to meet the requirements of chassis manufacturers, certain chassis and underbody components of your motor home have been coated with an undercoating material. This material is intended to assist in protecting these components from corrosion or other effects of weather and road conditions. Please be aware that certain areas of the motor home do not have undercoating applied.

See the *Chassis Operator's/Owner's Guide/Manual* in the *Owner's Information Package* for chassis fuel recommendations. The optional generator is designed to run on the same fuel as the chassis. Consult the generator operating instructions for special cautions about maintenance with different types of fuels.

Modern fuel systems may build up vapor pressure within the tank as the fuel warms during use or hot weather. Under certain conditions, sudden release of this pressure when removing the fuel cap can cause fuel to spray from the fill opening, creating a fire hazard.

To protect the fuel system from excessive pressure or vacuum, or from sudden release of pressure, replace lost or damaged fuel fill caps with caps of the same design which are available from your Fleetwood motor home dealer.

Clean up fuel spills immediately. Fuel spilled on the motor home could damage the exterior finish, and is a serious fire hazard.

FUEL AND FUEL SYSTEMS

	WARNING
When removing the fuel fill cap, rotate it slowly only far enough to allow the pressure to release. After any "hissing" sound stops, remove the cap completely.	

Your motor home's automotive fuel and emissions systems are sophisticated and engineered to meet Federal and State emissions standards. They are sometimes sensitive to fuel types and blends, particularly fuels blended for certain altitudes and climates. Fuel suppliers provide customers with the correct fuel for their location and seasonal conditions. Sometimes, though, fuel blended for winter is supplied during summer months.

FUEL TYPES AND VAPOR LOCK

"Vapor lock" occurs when gasoline vaporizes, and vapor pockets block the flow of liquid fuel to the engine. If you experience engine stall or stutter, you may be experiencing vapor lock. If your engine and fuel system are properly tuned and maintained, you should not experience this problem. If vapor lock occurs, the fuel itself could be the cause. If at all possible, check with the service station operator as to the fuel blend before filling your fuel tank. If you purchase your fuel from nationally recognized fuel dealers, your chances of vapor lock can be reduced. If you store your motor home during the winter months, be aware that when you take the vehicle out of storage in the spring or summer, winter fuel may cause vapor lock until it is consumed.

When the engine is under load or requires maximum cooling, the engine fan turns faster. The fan may become noisy at high speed and when maximum cooling is required. High speed fan noise can sometimes be misinterpreted as transmission slippage. This is not the case. This fan noise indicates that the fan is doing what it is supposed to do. This noise is not a defect in the fan or the transmission.

ENGINE FAN

EXHAUST SYSTEM HEAT

Your motor home engine has been designed to conform to Federal and State emission requirements. To meet these requirements, engine operating temperatures are high. As a result, the engine and exhaust systems radiate a great deal of heat.

Special heat shields are built into your motor home to protect wiring and other components from possible heat damage caused by the exhaust system. Do not remove these shields, modify the exhaust system, or add additional equipment, such as wiring, plumbing, or other components, which will be effected by exhaust system heat.

ENGINE TEMPERATURE GAUGES

Engine temperature gauges have been calibrated to indicate a midrange reading as the "normal" operating temperature. The reason for this is that many owners perceive 212°F as the boiling point. However, this is not the case in an engine with a pressurized cooling system and a coolant mixture of glycol and water. As a motor home owner, be aware that the gauge is intended to provide a warning of any rapid change in engine coolant temperature from the "normal" reading of the gauge rather than an absolute temperature reading.

ON THE ROAD

Carbon monoxide is a colorless, tasteless, odorless gas. It is a by-product of the burning of fossil fuels (gasoline, LP gas, diesel fuel, etc.). The chassis and generator engines, furnaces, water heater, LP gas refrigerator and range in your motor home produce it constantly while they are operating. **CARBON MONOXIDE IS DEADLY.** Please read and understand the following precautions to protect yourself and others from the effects of carbon monoxide poisoning.

Beware of the symptoms of exhaust gas (carbon monoxide) poisoning:

Dizziness

Vomiting

Nausea

Muscular twitching

Intense headache

Throbbing in temples

Weakness and sleepiness

Inability to think clearly

If you or others experience any of these symptoms, get out into fresh air immediately. If symptoms persist, seek medical attention. Shut down the unit and do not operate it until it has been inspected and repaired.

 **WARNING**

Do not under any circumstances operate any engine while sleeping. You would not be able to monitor outside conditions to assure that engine exhaust does not enter the interior, and you would not be alert to exhaust odors or symptoms of carbon monoxide poisoning.

CARBON MONOXIDE SAFETY PRECAUTIONS

 **WARNING**

Exhaust gases are deadly. Do not block the tailpipes, or exhaust ports, or situate the vehicle in a place where the exhaust gases have any possibility of accumulating either outside, underneath, or inside your vehicle or any nearby vehicles. Outside air movements can carry exhaust gases inside the vehicle through windows or other openings remote from the exhaust outlet. Operate the engine(s), carbon monoxide-producing systems or components only when safe dispersion of exhaust gases can be assured. Monitor outside conditions to be sure that exhaust continues to be dispersed safely.

Your motor home is equipped with a carbon monoxide (CO) detector/alarm. It is usually located in the main sleeping area.

If the indicator sounds, it is an indication that carbon monoxide gas is present. This may occur while idling in high traffic concentrations or in campgrounds where other vehicles as well as your motor home are contributing to the carbon monoxide level in the surrounding air. Sounding of the alarm does not indicate a faulty alarm. The detector is doing its job of warning you of potentially high concentrations of carbon monoxide. See the section on *Carbon Monoxide* in this manual.

Test the CO detector/alarm after the motor home has been in storage, before each trip, and at least once a week during use. Please refer to the operating instructions included in your *Owner's Information Package*.

CARBON MONOXIDE DETECTOR/ ALARM

The only safe and approved towing methods are either an under reach wheel lift device, as installed on a minimum 3-ton tow truck chassis, or a flat bed trailer. Most tow truck operators willing and able to tow motor homes will be familiar with these devices. Be prepared to give the tow truck operator at least the following information when you call:

Length and height of motor home

Chassis manufacturer

Gross vehicle weight rating

When towing with an under reach lift device, the vehicle must be towed from the front, either on the rear wheels (if operational) or on a heavy duty dolly. Consult your *Chassis Operator's/Owner's Guide/Manual*. Contact the chassis assistance center prior to calling a tow company to receive tow instructions and possible assistance with coordinating the tow.

EMERGENCY TOWING

	CAUTION
Do not tow the motor home from the rear. Towing from the rear will cause serious overloading of the front tires and suspension, possibly resulting in tire or front suspension failure. The rear frame extensions are not designed to withstand the load imposed by lifting from the rear.	

ON THE ROAD

To prepare your motor home for towing:

1. Secure any loose or protruding parts of the disabled vehicle.
2. Secure any heavy, loose items in the interior.
3. Turn off LP gas appliances and the LP gas tank valve.
4. Do not allow any person to ride in the towed vehicle.

Structural members are located specifically to mount and attach factory-installed components and accessories, and may not be located to support after-market accessories not specifically designed for use on or in your motor home.

Please consult with your dealer before attempting to install or mount accessories on the sidewalls of your motor home. Holes drilled in the sidewall may cause damage, and may affect portions of your warranty coverage.

ATTACHING ACCESSORIES TO YOUR MOTOR HOME

LIVING WITH YOUR MOTOR HOME

Entry steps are located under each entry door (not under driver and passenger doors). To extend the manual step pull step assembly out; let it down completely. Push step all the way in to store.

MANUAL ENTRY STEPS

 **WARNING**

The distance between the motor home and the ground is too far to easily manage. Be sure the step is out before exiting the motor home.

The power entry step is controlled by the ignition switch and by a switch near the entry door. Power for the entry step is supplied by the coach battery. The battery must be connected for the step to operate as described below. The step has a "last out" feature. With the door closed, the step power switch OFF, turn the ignition switch ON. The step will retract. Turn OFF the ignition, open the door and the step will extend and lock in the OUT position. The switches operate the step according to the following table.

POWER ENTRY STEPS

 **WARNING**

Under certain conditions, the step may not extend using the last-out feature. Always look and be sure the step is extended before exiting the motor home.

Ignition Switch Position	Step Switch Position	Step Position/ Action
OFF	ON	Step extends and retracts with the opening and closing of the door.
OFF	OFF	Step is inactive. Will not move regardless of door movement.
ON	ON	Step extends and retracts with opening and closing of door.
ON	OFF	Step extends and retracts with opening and closing of door. If step is extended when ignition is turned ON, step will retract.

Living With Your Motor Home

An entry assist handle is located outside each entry door.

ENTRY ASSIST HANDLE

The main entry door uses a latching system similar to that used in automobiles. It has a secondary or safety latch as well as a primary latch. When closing the door, be sure to close it firmly to advance the latch past the safety position and engage the primary latch. This will ensure that the door is fully closed. **When traveling always lock the deadbolt.**

ENTRY DOORS AND SCREENS

The screen door may be separated from the main entry door by depressing the catch or releasing the magnet. A holdback mechanism can be used to secure the main door against the side of the motor home.

Windows in your motor home are either slider or torque pane type. Slider windows may be locked by turning the locking lever. Torque windows may be opened and adjusted by turning the knob or crank located at the bottom of the window.

WINDOWS

Any ventilating window may permit water inside. This water must be trapped and provisions made for draining it to the outside.

On your ventilating windows, water is trapped by the frame. During a heavy downpour, water may be seen in the lower portion of the frame. The sloping sill and weep slots allow the water to drain to the outside. These weep slots must be kept open.

If water collects in the bottom channel and overflows, check the weep slots for debris and obstructions.

Living With Your Motor Home

Read and understand these instructions before you need to use them. The emergency exit window provides an emergency means of escape if the motor home doors are blocked or disabled for any reason or in case the motor home must be evacuated under emergency conditions.

EMERGENCY EXIT WINDOW

Unlock and slide window and/or screen to open and close.

SIDE SLIDER WINDOWS



NOTE

Screens are not removable for cleaning. They may be pushed out of their frames if the window must be used for emergency exit. In this case, the screens will be destroyed and will probably have to be replaced.

The sun visors at the driver's and passenger's positions swing down and adjust to provide relief from glare and bright skies.

SUN VISORS

To raise window shades:

Push up from bottom.

To lower window shades:

Pull straight down on the shade.

Stop the shade in mid-travel by moving it to the desired position.

WINDOW SHADES (SOME MODELS ONLY)

Living With Your Motor Home

To raise mini-blinds:

Push up from bottom.

To lower mini-blinds:

Pull straight down on the blind.

Stop the blind in mid-travel by moving it back to the desired position.

To adjust the angle:

Turn the adjusting rod either direction.

Exterior storage compartments maximize available space and should accommodate most of your storage needs. All of the storage compartments, except the LP gas compartment, can be locked. Fire-prevention regulations require that the LP gas compartment be unlocked at all times.

When storing equipment and supplies:

- » Always keep tools and equipment stored in areas where they will not shift while traveling.
- » Whenever possible, place heavy articles in storage compartments which are low and in the best location for better weight distribution.
- » Pack articles carefully in the storage compartments to minimize shifting. If necessary, use straps to prevent movement.
- » Be sure liquid containers are capped and cannot tip or spill. Secure all glass containers and dishes before traveling.
- » Exterior storage compartments may not be water-tight in all climate conditions. Carry any articles which could be damaged by water inside the motor home.

MINI-BLINDS

STORAGE

EXTERIOR COMPARTMENTS

 **NOTE**

*Your motor home could be overloaded or out of balance if not properly loaded. Refer to the **Motor Home Loading** section in this manual, and follow the loading and weighing instructions in that section.*

 **WARNING**

Do not store flammable, volatile liquids or hazardous chemicals inside the motor home or in outside storage compartments. Toxic fumes from these liquids or chemicals may enter the interior of the motor home.

Living With Your Motor Home

INTERIOR STORAGE

The closets and cabinets have friction catches or hidden latches along one edge of the door. Overhead doors may have supports to hold them open.

Drawers rest in notches when they are closed. To open drawers, lift up slightly, then pull open.

Closets may be equipped with 12-volt lights that may be switched to turn ON when the closet door is opened. Be sure the light goes OFF when the closet door is closed - your battery will be discharged if it stays ON. If the light stays on when the door is closed, the door switch requires adjustment. The same loading considerations apply to interior storage areas as to exterior. Consult the *Motor Home Loading* section in the *On The Road* chapter.

The materials used inside your motor home have been selected for durability and comfort. With reasonable care, these materials will stand up under years of recreational living. The *Maintenance* chapter in this manual outlines care requirements for the various upholstery fabrics, floor, cabinet, and wall finishes.

INTERIOR AND FURNISHINGS

To convert the dinette into a bed:

1. Unfasten and remove cushions.
2. Reach under the table, fold the legs up under the table top.
3. Raise front portion of table several inches to disengage inserts from the wall supports.
4. Lower table top to the dinette frame to complete bed base.
5. Slide seat and back cushion into place over bed base

DINETTE CONVERSION

Living With Your Motor Home

To convert a sofa/lounge into a bed:

1. Remove sofa bolsters.
2. Lift front of sofa frame up and out.
3. Push the back of the lounge back and down.
4. Push the seat belts through the space between the lounge back and seat.

SOFA/LOUNGE CONVERSION

To restore the sofa/lounge:

1. Pull the seat belts back up through the space.
2. Lift the front edge of the sofa frame up, and push it back. The sofa back will come up.
3. Push the sofa into position.

The dividers allow you to separate areas in the motor home. They glide on plastic slide tracks and do not require lubrication. They are held closed by a catch. When the dividers are open for traveling, be sure to attach the hold back straps to keep them from sliding back and forth.

FOLDING DOORS/ PRIVACY CURTAIN DIVIDERS

Both decorative and "utility" style 12-volt lighting fixtures may be used in your motor home.

INTERIOR LIGHTING

Utility style fixtures may be either single or dual. A rocker switch selects either single or dual brightness. For your convenience, some lights are operated from wall switches. Clean the lenses in soapy water.

LIVING WITH YOUR MOTOR HOME

OVERHEAD VENTS

Overhead vents are located in the galley (some models) and bathroom areas for fresh air circulation and exhausting heat, odors, and water vapor.

Turn the crank in the center of the vent to open and adjust. Some vents may also be equipped with a 12-volt fan. A switch controls fan operation. Be sure to turn the fan OFF before closing the vent.

Close the vents or lower them before traveling to avoid damage from wind and low overhead clearances.

The vents may be cleaned from the top of the motor home. Use soapy water on the vent cover. The screens may be vacuumed or lightly brushed to remove accumulation of leaves or other debris.

Lubricate the gears and mechanism yearly with a light, water resistant grease.

The monitor panel allows you to conveniently check the approximate levels in tanks and to check battery condition(s).

MONITOR PANEL

Electrical probes installed in the tanks measure the levels at various points in the tanks.

To check tank levels:

Press LP GAS, WATER or HOLDING TANK 1 or 2 rocker switches. HOLDING TANK 1 is the black water (toilet waste) tank, and HOLDING TANK 2 is gray water (sink and shower wastes).

The E or empty indicator light will always be lit when the rocker switches are depressed. If the tank is full, all lights will be on. Lights are sequential, and indicate the level in approximately $\frac{1}{4}$ tank increments. If the tank selected is approximately $\frac{1}{2}$ -full, for example, lights E, $\frac{1}{4}$ and $\frac{1}{2}$ will be on.

Living With Your Motor Home

Erroneous tank level indications can be caused by:

- a. Water with low mineral content. The level is measured by a very low level electrical signal traveling through the liquid. Some water may not conduct the signal properly. This condition may be infrequent, but can exist. Check the panel reading when the fresh water tank is filled.
- b. Material trapped on the sides of the holding tanks may give a full reading when the tank is actually empty.

To check the battery charge:

1. Unplug the 120-volt AC power cord to turn the power converter off.
2. Press BATTERY rocker switch on the panel.
3. Turn on a light or any 12-volt appliance. The battery must be checked with a load.
4. Read battery condition on the meter. Red is low, yellow is fair and green is good.

	NOTE
<i>If the sensor probes mounted in the tanks get coated with grease, the monitor panel may indicate falsely or not at all. Avoid pouring grease, oils or similar substances down drains or the toilet. If this is unavoidable, the holding tank(s) should be washed out with a soapy water solution. See your dealer for additional information.</i>	

Your RV was designed primarily for recreational use and short term occupancy. If you plan to stay in it for longer than a couple of days, you need to understand how to properly manage and control the humid conditions and condensation that you may experience.

Modern RVs are much smaller than a house, and are tightly built. This means that the interior air will become saturated with moisture more quickly. The routine activities of a few people can put a lot of water into the air. In cold weather, this moisture may become visible as condensation.

Condensation happens naturally. Just as moisture collects on the outside of a glass of cold water during humid weather, moisture can condense on the inside surfaces of your RV during cold weather when the humidity of the interior air is high.

EFFECTS OF PERMANENT OCCUPANCY

CONDENSATION AND HOW TO CONTROL IT

Water vapor will condense on the inside of the windows and walls. In really cold weather, frost or ice may appear. *It may also condense out of sight within the walls or the ceiling.* If enough water collects in the wall or ceiling materials, it may cause water stains on the wall or ceiling surface. You might think that your walls or ceiling are leaking. You have a problem with condensation if you see these signs. You need to do something to reduce the moisture inside your RV.

If you locate your RV in an area that experiences cold winter temperatures, you may experience the effects of condensation. Even though you can't eliminate it completely, you can reduce or eliminate its effects.

Here are some frequently asked questions about condensation and some answers that will help you understand more about your RV and how to keep it comfortable.

Q. – In cold weather, my windows and walls look like they're sweating. Is that condensation?

A. – Yes. Your windows are a good way to know if the humidity in your RV is too high. All air contains water vapor. When air is warm it can hold much more water vapor than when it is cold. When the air cools, the water vapor "condenses" back to a liquid. Since your windows are usually cooler than the air, the water collects on the surface of the glass.

Q. – Isn't my insulation supposed to keep my RV warm? Is something wrong with my RV?

A. – Yes, your insulation is designed to keep your RV comfortable in cold weather. Not only do you have superior insulation, but your RV is tightly built to close manufacturing tolerances. Your RV really holds the air in.



NOTE

Your RV is not designed to be used as permanent housing. Use of this product for long term or permanent occupancy may lead to premature deterioration of structure, interior finishes, fabrics, carpeting and drapes. Damage or deterioration due to long term occupancy may not be considered normal, and may under the terms of the warranty constitute misuse, abuse, or neglect, and may therefore reduce your warranty protection.

Living With Your Motor Home

And no, there is nothing wrong with your RV. Quite the opposite is true. Most homes have large cracks and spaces that allow moist air to escape to the outside. But the windows and doors in your RV are tightly sealed. Air just has a hard time getting through to the outside.

Q. – Where does all the water come from?

A. – Moisture in the air comes from many sources. Some of the most common are:

Cooking – Meals prepared for a family of four can add up to a gallon of water per day into the air from cooking.

Bathing – An average shower puts between $\frac{1}{4}$ - $\frac{1}{2}$ pounds of water into the air. It takes four tub baths to equal that amount.

Dishwashing – Doing the dishes for a typical day's meals can add up to one pound of water to the air.

Floor mopping – When an 8' x 10' kitchen floor is mopped and rinsed, almost $2\frac{1}{2}$ pounds of water are released in the air.

Clothes drying – After 10 pounds of clothes have been washed and spin-dried in a washer, they still contain about 10 pounds of water. If these clothes are dried inside, that water is released into the air in the RV.

Gas appliances – When gas is burned, carbon dioxide, nitrogen and water are given off into the air. For every 1000 cubic feet of gas burned, nearly 88 pounds of water is released into the air.

Humidifiers – Humidifiers are designed to put moisture into dry air – up to two pounds per hour. So in a 24-hour period, an uncontrolled humidifier can put almost 50 pounds of water into the air.

House plants and aquariums – Plants give off almost as much water as you put on them. And open aquariums permit higher rates of evaporation than closed types.

LIVING WITH YOUR MOTOR HOME

People and animals – A large source of water in the RV is the inhabitants themselves. A family of four can put up to 12 pounds of water into the air per day through breathing and perspiration.

As you can see, just the normal course of living adds a great deal of water to the air.

Q. – What will all this water do to my RV?

A. – The least it will do is fog your windows. If it is really cold outside, frost or even clear ice could form on the inside of the glass.

Excessive moisture in the air could show up as water running down or dripping off walls, ceilings or fixtures. It may look like your roof or windows are leaking. This water may stain woodwork, carpeting, ceiling panels or even furniture.

But the most damage is caused by water you can't even see. Water will penetrate almost any material – except glass and metals. Water vapor in the air always wants to move toward dry air. Scientists call this “vapor pressure” action. It will go through walls, floor covering, plywood, paint – just about anything. The water that gets trapped in these materials can cause warping, mildew, paint failure and rotting.

The damage caused by excessive humidity can be invisible, and worse, expensive to fix. Please remember that this damage is not covered under the warranty.

Q. – What can I do to reduce or eliminate condensation problems in my RV?

A. – The two most important things are:

***Reduce moisture released into the air
and increase ventilation***

Living With Your Motor Home

To reduce moisture released inside the RV:

1. Run the vent fan when cooking and the bath vent fan (or open the bath vent) when bathing. Avoid making steam from excessive boiling or use of hot water. Remove water or snow from shoes before entering to avoid soaking the carpet. Avoid drying clothes inside (except in the dryer, if equipped). The water drying out of the clothes goes into the air.
2. If you set up your RV in a semipermanent situation, cover the ground under it with a vapor barrier material.
3. Vent appliances to the outside. Your clothes dryer should always be vented according to the dryer manufacturer's installation instructions, if required. (Some dryers are designed to be ventless and do not require a vent to the outdoors.) Check the vents periodically to be sure they are not blocked.
4. Avoid placing pans of water on the stove or in heat ducts to raise the humidity.
5. If you operate or use vaporizing inhalers, or similar devices, always provide adequate ventilation.
6. Never use open flame gas or kerosene-burning heaters indoors. These devices release water into the air, and the exhaust gases contain poisonous substances.

To increase ventilation:

1. Use the kitchen and bath exhaust fans, if equipped, when cooking or bathing. Let them run for a while after a bath or meal.
2. Ventilate with outside air. Partially open one or more roof vents and/or windows to provide circulation of outside air into the interior. While this ventilation will increase furnace heating load, it will greatly reduce, or eliminate, condensation. Even when it is raining or snowing, outside air will be far drier than interior air and will effectively reduce condensation.

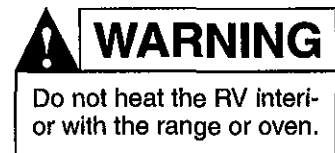

3. Avoid taping windows or doors tightly closed. This will prevent any air movement and will make the condensation problem worse.
4. Ventilate closets and cabinets. During prolonged use in very cold weather, leave cabinet and closet doors partially open to warm and ventilate the interiors of storage compartments built against exterior walls. The air flow will warm the exterior wall surface, and reduce or eliminate condensation, and prevent possible ice formation. Avoid crowding closets or wardrobe space. Overstuffed closets restrict air flow.
5. Stock kitchen and bath cabinets to allow free air circulation.
6. Open drapes over windows as often as possible and convenient.
7. Install a dehumidifier appliance. During prolonged, continuous use, a dehumidifying appliance may be more comfortable and effective in removing excess moisture from the interior air. Use of a dehumidifier is not a "cure-all." Ventilation and moisture reduction are the most effective ways to eliminate excess moisture. But operation of a dehumidifier will reduce the amount of outside air needed for ventilation. Heating load on the furnace will be reduced, and the interior will be less drafty.
8. Ventilate while driving. Positive air ventilation will help reduce the build-up of moisture while driving. The movement of the RV at highway speeds can draw air from the outside through the windows or vents.
9. Control the interior heat. If the heat is a dry heat, the humidity will tend to be lower. Here are some tips on controlling humidity with heat:
 - *Clean furnace air filters regularly to keep good air circulation.*
 - *Keep registers and the furnace blower clean and unobstructed. This helps air circulation.*
 - *Do not operate a humidity device on your furnace.*



Living With Your Motor Home

During cold weather and even in short term occupancy, condensation frequently forms on ceiling vents and may even accumulate to the point of dripping onto the surfaces below. This is frequently misinterpreted as a "leaking" roof vent but is most often condensation drippage. Follow the preceding steps to control moisture condensation, and protect surfaces with plastic sheeting until the moisture has dissipated.

DRIPPING CEILING VENTS

The hazard and possibility of fire exists in all areas of life, and the recreational life-style is no exception. Your motor home is a complex machine made up of many materials - some of them flammable. But like most hazards, the possibility of fire can be minimized, if not totally eliminated, by recognizing the danger and practicing common sense, safety and maintenance habits.

FIRE SAFETY

The fire extinguisher furnished with your motor home is rated for Class B (gasoline, grease, flammable liquids) and Class C (electrical) fires since these are the most common types of fires in vehicles. Read the instructions on the fire extinguisher. Know where it is located and how and when to use it.

Remember that portable fire extinguishers are appliances intended for use only by the occupants of a building or area that is threatened by fire. They are most valuable when used immediately on small fires. They have a limited amount of fire-extinguishing material, and therefore must be used properly so this material is not wasted.

Fire extinguishers are pressurized, mechanical devices. They must be maintained as outlined and any maintenance instructions provided with the device so they are ready to operate properly and safely. Parts or internal chemicals may deteriorate in time and need replacement. Always follow maintenance and recharging instructions provided by the fire extinguisher manufacturer.

Living With Your Motor Home

Explosive fuel clouds may be present at fuel filling stations.

Instruct occupants on what to do in case of fire, and hold fire drills periodically.

Maintain proper charge in the fire extinguisher.

If you experience a fire while traveling, ***Maintain control of the vehicle until you can safely stop. Evacuate the vehicle as quickly and safely as possible.***

If you experience a fire while camped, ***Evacuate the vehicle as quickly and safely as possible.***

Consider the cause and severity of the fire and the risk involved before trying to put it out. If the fire is major or is fuel-fed, move away from the side of the LP gas tank, stand clear of the vehicle and wait for the fire department or other emergency assistance.

If your motor home is damaged by fire, do not drive or live in it until you have had it thoroughly examined and repaired.

FIRE SAFETY PRECAUTIONS



WARNING

Before refueling (either gasoline, diesel, or LPG) be sure to turn off all pilot flames and appliances in your motor home. Turning off the propane at the tank is insufficient. Pilotless appliances may still spark or pilot flames may not extinguish immediately.



WARNING

Do not store or carry LP gas containers, or other flammable liquids inside your motor home.

LIVING WITH YOUR MOTOR HOME

A battery-powered smoke detector/alarm is mounted on the ceiling or wall in the living/cooking area of your motor home. Please read the smoke detector/alarm operating instructions for details on testing and caring for this important safety device.

Test the smoke detector/alarm after the motor home has been in storage, before each trip, and at least once a week during use.

The smoke detector/alarm should never be disabled due to nuisance or false alarm from cooking smoke, a dusty furnace, etc. Ventilate your motor home with fresh air and the alarm will shut off. **Do not disconnect the battery.**

Replace the battery once a year or immediately when the low battery BEEP signal sounds.

If the smoke detector/alarm fails to operate with new batteries, replace it with a new unit, available through an authorized Fleetwood Service Center.

SMOKE DETECTOR/ALARM

WARNING

Urethane foam is flammable!

Do not expose urethane foams to open flames or any other direct or indirect high temperature sources of ignition such as burning operations, welding, burning cigarettes, space heaters or unprotected electric light bulbs.

Once ignited, urethane foams will burn rapidly, releasing great heat and consuming oxygen at a high rate. In an enclosed space the resulting deficiency of oxygen will present a danger of suffocation to the occupants. Hazardous gases released by the burning foam can be incapacitating or fatal to human beings if inhaled in sufficient quantities.

The slide-out room is designed to provide additional living space for site set-up.

There are two types of slide-outs available as standard or optional equipment on your motor home. A detailed operating and maintenance guide is included in your **Owner's Information Package**. Read all instructions for these systems carefully before operating the slide-outs.

SLIDE-OUT ROOMS (SOME MODELS)

CAUTION

Never attempt to move your motor home with the slide-out room(s) extended. Damage can occur to the slide-out or motor home.

PLUMBING SYSTEMS

The plumbing systems in your motor home are constructed of thermoplastic materials. Holding tanks and piping components are strong, lightweight, and corrosion resistant.

Fresh water is available from either an external "city water" hookup or on-board storage.

The external system is pressurized by the water system at an RV park or city water supply.

FRESH WATER SYSTEM

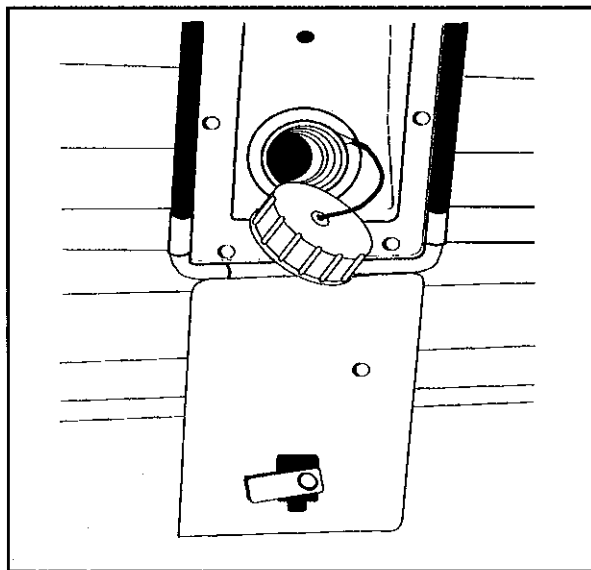

Filling the Water Tank

CAUTION

Since water pressures at campgrounds vary, we recommend you install an in-line pressure regulator at the water supply faucet. This will protect the motor home water system and your supply hose from excessively high water pressure.

PLUMBING SYSTEMS

Connect the city water system as follows:

1. Connect one end of a potable water hose to park or city water supply. This will usually be a faucet or valve similar to your garden hose valve at home. "Potable water" hoses are available at RV supply stores.
2. Run the city water supply for a few seconds to clear the line.
3. Turn OFF the supply.
4. Connect the hose to the inlet fitting.
5. Turn ON the supply. Open all faucets and clear the lines. Close faucets.

Disconnect the city water as follows:

1. Close the park or city water supply valve.
2. Remove the hose from the city water supply valve.
3. Disconnect the hose from the inlet, coil and store it.

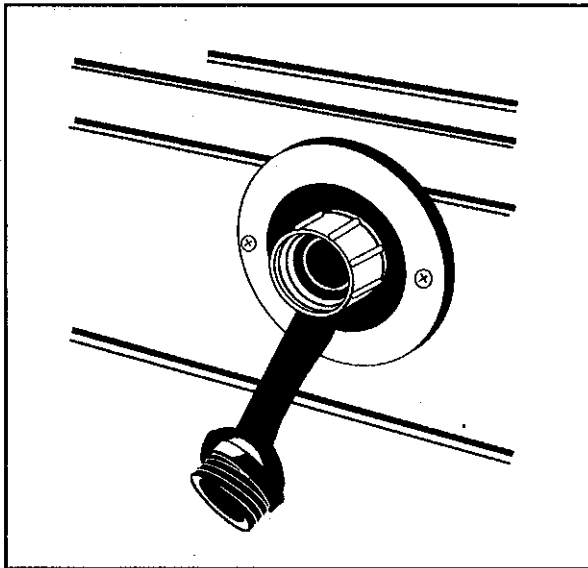

City Water Connection

CITY WATER CONNECTION



CAUTION

Overfilling the fresh water tank from a pressurized source will cause serious damage to the water tank or structural components. Monitor water tank filling continually.

The on-board water storage tank may be filled through a special filler cap outside the motor home. To fill the fresh water tank, open the spout, and fill the tank using a potable water hose. Check the monitor panel often to determine when the tank is full. If water is flowing from the top vent, your tank is overfilled. Stop filling. After filling the tank, replace vent plug and filler cap.

Avoid leaving water in the tank when the motor home is not in use. Turn the water pump ON while draining the water tank. Whenever possible, drain the fresh water tank before traveling. Water in the tank will reduce the carrying capacity of the motor home. See *Motor Home Loading* section of the *On The Road* chapter.

The on-board fresh water system is pressurized by a self-priming, 12-volt DC pump. The pump operates automatically when the pump power switch is ON and a faucet is opened. When the faucets are closed, the pump shuts off. At free flow, the pump draws approximately 7 to 7½ amps, and can run dry for extended periods without damage. A 15-amp fuse at the converter panel protects the pump circuit. See *Electrical Systems* chapter.

THE WATER PUMP

Turn the pump master switch ON to pressurize the system. When a faucet is opened after the initial filling of the tank, the water may sputter for a few seconds. This is normal and is not cause for concern. The water flow will become steady when all air is bled from the water lines.

Plumbing SYSTEMS

Dirt, mineral scale, and organic matter are filtered out of the fresh water system by an in-line water filter on the inlet side of the water pump. If you suspect a clogged filter, it is easily removed and cleaned.

WATER FILTER

Inspect the filter after the first 90 days of use, clean if necessary, and inspect annually thereafter.

1. Turn water pump switch OFF and unscrew the water line fitting from the filter.
2. Unscrew the filter from the water pump.
3. Turn each end of the filter and pull apart.
4. Flush out and clean screen.
5. Reverse procedure to install.
6. Operate the water pump and check for leaks.

Water system problems usually fall into two categories: inherent system problems, and problems caused by neglect. System problems are usually the result of road vibration and campsite water pressure variations. Problems of neglect usually stem from failure to clean filters, improper winterization, and poor battery maintenance. Most water system problems can be avoided by conscientious maintenance.

TROUBLESHOOTING THE FRESH WATER SYSTEM

Vibration, flexing and twisting while traveling can work pipe fittings loose. Check all plumbing for leaks at least once a year. If the water pump runs when a faucet is not open, suspect a leak. Be sure the tank drain valves are tightly closed. Leaks occur most often around threaded fittings. If necessary, tighten or clean and tighten the fittings. Do not over-tighten fittings. Connections at galley and lavy fixtures should not be tightened with a wrench. They will normally seal with hand-tightening. If a leak persists at one of the fittings, disconnect it completely and check for mineral deposits or other foreign matter at the seating surfaces. Clean the surfaces thoroughly and reinstall the fitting.

LEAKS

Connections at the water tank, pump and valves are made with special clamps. They can be replaced with standard aircraft type hose clamps.

Leaks caused by freezing damage can be prevented by proper winterization of the system. See *Storage* chapter of this manual. Freezing damage is usually extensive and may include a burst water tank, split piping, and a damaged water pump, toilet, and water heater. If you experience this type of damage, repairs can best be made by an authorized Fleetwood dealer.

Sanitize the fresh water tank and piping approximately every three months, and whenever the motor home sits for a prolonged period. This will discourage the growth of bacteria and other organisms that can contaminate the water supply. Use a chlorine/fresh water rinse as follows:

SANITIZING THE FRESH WATER SYSTEM

1. Prepare a solution of ¼-cup household liquid chlorine bleach (5% sodium hypochlorite) to one gallon of water for each 15 gallons of tank capacity.
2. Close drain valves and faucets, pour chlorine solution into the fresh water tank filler spout, and complete filling with fresh water.
3. Turn water pump switch ON. (Be sure you have 12-volt DC power.) Open all faucets individually until water flows steadily, then turn off. This will purge any air from the lines.
4. Top off water tank with fresh water and wait three hours.
5. Drain the entire system by opening all fresh water tank valves, faucets, and plumbing line drain valves.
6. Flush the system with drinking quality water. Let the fresh water flow through the system for several minutes to flush out the chlorine solution.
7. After you stop the flushing, close the tank valve, faucets, and drain valves. You can now fill the tank with fresh water, and the system is ready to use.

Plumbing SYSTEMS

A shower fixture is located in an exterior compartment on selected models. The water pump must be ON or city water pressure must be available for the shower to operate.

EXTERIOR SHOWER (SOME MODELS ONLY)

The waste water system in your motor home is made up of sinks, tub, shower, toilet, plumbing drain and vent lines, a grey water holding tank, and a black water holding tank. Generally, water from the sinks and shower drains into the grey water tank; the toilet drains into the black water tank. The holding tanks make the system completely self-contained and allow you to dispose of waste water at your convenience. A flexible sewer hose is required to connect the holding tank outlet to the inlet of an approved waste water dump station or sewer system.

WASTE WATER SYSTEM

The drain plumbing is similar to that used in your home. The system is trapped and vented to prevent waste gases from backing up into the motor home. The drain plumbing is made of ABS plastic, and is durable and resistant to most chemicals.

Your motor home is equipped with a marine-type toilet. Please follow the operating instructions found in your *Owner's Information Package*.

TOILET



NOTE

Prior to flushing solid wastes, fill the bowl with water to within 2"-3" from the top.

DRAINING THE HOLDING TANKS

The holding tanks terminate in a valve arrangement that permits draining each tank separately or together. The valves are called “knife valves.” A blade closes the opening in the sewer drain pipes. The blade is connected to a T-handle that is pulled to release the contents of the tank(s). During self-containment use, the sewer line is securely capped to prevent leakage of waste material onto the ground or pavement. **Do not pull the holding tank knife valve open when the protective cap is installed on the pipe.** Always drain the tank into an acceptable sewer inlet or dump station.

Whenever possible, drain the holding tanks before traveling. Waste water and sewage in the holding tanks reduce the carrying capacity of the motor home. See *Motor Home Loading* section of the *Living With Your Motor Home* chapter.

Drain the holding tanks only when they are at least $\frac{3}{4}$ full. If necessary, fill the tanks with water to $\frac{3}{4}$ full. This provides sufficient water to allow complete flushing of waste material into the sewer line.

During extended or semi-permanent hookups to sewage systems, waste materials will build up in the tank and cause serious plugging if the tank valves are continuously open. In these cases, keep the valves closed until the tanks are $\frac{3}{4}$ full, and then drain into the sewage system.

The holding tank drain valve outlet is to be used with a removable termination fitting that locks onto the outlet with a clockwise twist. Clamp the sewer drain hose to this fitting. A protective cap should remain in place when you are not draining the tanks.

 **WARNING**

Holding tanks are enclosed sewer systems and as such must be drained into an approved dump station. Both black and grey water holding tanks must be drained and thoroughly rinsed regularly to prevent accumulation of harmful or toxic materials.

 **NOTE**

Local or state regulations may prohibit highway travel unless the holding tank outlet is securely capped.

PLUMBING SYSTEMS

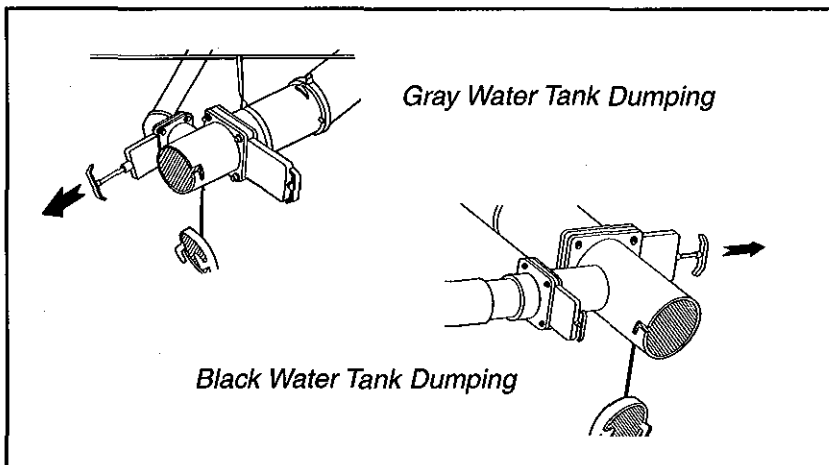

To drain the holding tanks:

1. Attach the sewer hose to the holding tank outlet. Insert the end of the hose into the sewer or dump station inlet, pushing it firmly far enough into the opening to be secure. In some cases, adapters may be necessary between the line and the inlet. Arrange the sewer hose so it slopes evenly.
2. Drain the black water holding tank first. Grasp the handle of the black water knife valve (the large one) firmly and slide the valve open with a quick, steady pull.
3. Allow enough time for the tank to drain completely. Rinse and flush the tank through the toilet. When the tank is empty, push the handle in to close the valve. Run enough water (up to five gallons) into the tank to cover the bottom. This will aid the break up of solid wastes and reduce "pyramiding" of waste.
4. To drain the grey water tank, repeat the steps above using the small knife valve. This tank is drained last to aid in flushing the outlets and hose. The grey water knife valve may be left open in a semi-permanent hookup.
5. Remove the sewer hose and cap the outlet.
6. Rinse out the sewer hose with fresh water and remove the sewer hose from the dump station.
7. Replace sewer or dump station covers.

Please...Practice good housekeeping when draining wastes at a campsite or disposal station. Leave the site in good order. Above all, do not pollute.

HOLDING TANK CARE

Since holding tanks don't rely on any sophisticated mechanical devices for their operation, they are virtually trouble free. The most common problem is also an unpleasant one — clogging. You can minimize the chances of clogging by keeping the following considerations in mind:

- » Keep the black water tank knife valve closed. Fill tank to at least $\frac{3}{4}$ full before draining. Be sure to cover the tank bottom with water after draining.
- » Use only toilet tissue formulated for use in septic tank or RV sanitation systems.
- » Keep both knife valves closed and locked, and the drain cap tightly in place when using the system on the road.
- » Use only cleaners that are approved for use in septic tank or RV sanitation systems.
- » Use a special holding tank deodorant chemical approved for septic tank systems in the black water holding tank. These chemicals aid the breakdown of solid wastes and make the system much more pleasant to use.
- » Do not put facial tissue, paper, ethylene glycol-based or other automotive antifreeze, sanitary napkins or household toilet cleaners in the holding tanks.
- » Do not put anything solid in either tank that could scratch or puncture the tank.

Plumbing SYSTEMS

If the drain system does get clogged:

- » Use a hand-operated probe to loosen stubborn accumulations. Seriously clogged P-traps may require disassembly. Be careful not to overtighten when reassembling.
- » Do not use harsh household drain cleaners.
- » Do not use motorized drain augers.
- » Sometimes the holding tank valve will get clogged. In this case, a hand-operated auger may be necessary. Be ready to close the valve quickly once the clog is cleared. If the seal gets damaged, it is easily replaced.

ELECTRICAL SYSTEMS

Your motor home is equipped with three electrical systems:

the chassis 12-volt system

the Fleetwood 12-volt house and automotive system

the 12-volt AC system.

They operate together to give you electrical power for many different situations.

These electrical systems comply with all regulations, codes, and standards in effect at the time the motor home was built.

This is the chassis 12-volt or vehicle electrical system. It includes:

the vehicle battery

engine battery/house battery charging system

ignition system

instrument panel and controls

the headlights, taillights, turn signals

other vehicle lights and accessories.

CHASSIS 12-VOLT ELECTRICAL SYSTEM

Replace bulbs with equivalent types as marked on the bulb.

Fuses for the chassis electrical system are located under the instrument panel on the left. Additional fuses may be located under the hood. Others may be found in the 12-volt power leads on the related equipment and accessories.

CHASSIS BULBS AND FUSES

ELECTRICAL SYSTEMS

All 12-volt lighting fixtures, convenience outlets, 12-volt powered vents, fresh water pump, and 12-volt accessories are included in this system.

The 12-volt power is provided by special deep-cycle, high capacity coach storage battery/ies. Power is also provided by an AC/DC power converter for use when the motor home is plugged into a 120-volt power source. Battery charge is maintained by the motor home engine alternator, or by the converter.

12-VOLT COACH SYSTEM



NOTE

All living area radios and tape decks draw from the chassis or coach battery, and extended usage when not traveling may discharge them.

The **Auxiliary Start System** permits using the coach battery to start the motor home engine if the chassis battery is discharged.

AUXILIARY START SYSTEM

To use the Auxiliary Start System:

1. Be sure the vehicle is stopped, shift to "P" (PARK) and apply the parking brake.
2. Press and hold the Auxiliary Start switch on the instrument panel.
3. Start engine with ignition switch.
4. Release Auxiliary Start switch.

The **Auxiliary Start System** has no effect on the vehicle except to aid in starting the motor home engine. If the vehicle alternator is operating properly, the batteries will be recharged while driving.

Check the external condition of the battery periodically. Look for cracks in the cover and case. Check the vent plugs and replace if they are cracked or broken. Keep the battery clean. Accumulations of acid film and dirt may permit current to flow between the terminals and discharge the battery.

To clean the battery:

1. Wash it with a diluted solution of baking soda and water to neutralize any acid present.
2. Then flush with clean water. Foaming around terminals or on top of the battery is normal acid neutralization. Avoid getting the soda solution in the battery. Be sure the vent caps are tight.
3. Dry the cables and terminals.
4. Don't use grease on the bare metal inside the cable terminals to prevent corrosion. Grease is an insulator. Electricity will not flow through it. A battery terminal spray will protect the terminals after you have cleaned and reinstalled them.
5. Check the battery often. Keep the carrier and hold down hardware clean and free of corrosion and chemical accumulation.

BATTERY INSPECTION AND CARE

 **WARNING**

Disconnect the 120-volt electric cord and the negative terminal from the coach battery/ies before working on either electrical system.

 **WARNING**

Remove rings, metal watchbands, and other metal jewelry before working around a battery. Use caution when using metal tools. If a tool contacts a battery terminal or metal connected to it, a short circuit could occur which could cause personal injury or fire.

 **WARNING**

Do not allow battery electrolyte to contact skin, eyes, fabrics, or painted surfaces. The electrolyte is a sulfuric acid solution which could cause serious personal injury or property damage. Wear eye protection when working with batteries.

ELECTRICAL SYSTEMS

Both sets of batteries will be kept charged by the chassis charging system while on the road. The AC/DC power converter will charge the coach battery when plugged into 120-volt service. On those occasions when the battery needs to be charged from a different charging source, please follow these guidelines:

- » Leaving a charger connected to a battery for an extended period of time can shorten battery life.
- » Do not smoke near batteries being charged or which have been recently charged. Please note that batteries are being charged while you drive, and while you are connected to 120-volt power through the converter/charger circuit.
- » Do not break live circuits at the terminals of the battery. Use care when connecting or disconnecting booster leads or cables. These actions, and poor connections, are a common cause of electrical arcs which can cause an explosion.
- » Check and adjust the electrolyte level before charging. Fill each cell to the indicator with distilled water.
- » Always remove vent caps before charging the battery.
- » Do not charge the battery at a rate that causes the electrolyte to spew out.
- » In cold temperature storage conditions batteries may freeze if not kept properly charged.

BATTERY CHARGING

	WARNING
Never expose the battery to open flame or electric spark. Chemical action in the battery generates hydrogen gas which is flammable and explosive. Do not allow battery electrolyte to contact skin, eyes, fabrics, or painted surfaces.	

ELECTRICAL SYSTEMS

When the battery requires replacement, always choose a battery with the same physical and electrical characteristics as the original equipment. Your dealer or an authorized Fleetwood Service Center can advise you on proper battery selection.

SELECTING A REPLACEMENT BATTERY

This system provides grounded electrical service for appliances such as air conditioners, TV, microwave ovens, etc. The 120-volt system also provides a power source for the converter.

120-VOLT SYSTEM

Your motor home is equipped with a heavy duty power cord to connect to an external 120-volt, 30 amp AC service. The cord and connector are molded together to form a weatherproof cable assembly. Do not cut or alter the cable in any way. Do not remove the ground pin in the cable connector, or defeat the ground circuit in the motor home.

	WARNING
Do not operate the 120-volt electrical system without a proper ground. Electrocution or severe electric shock could result.	

The converter will automatically supply 12-volt power when your motor home is operating on 120-volt power from the generator or a public utility. It will also charge the coach battery.

POWER CONVERTER

Bathroom, galley and patio 120-volt electrical outlets are protected by a **Ground Fault Circuit Interrupter (GFCI)**. This device is intended to protect you against the hazards of electrical shocks possible when using electrical appliances in the bathroom or galley or in damp areas. Should a circuit or appliance (electric shaver, hair dryer, etc.) develop a potential shock hazard, the GFCI device is designed to disconnect the outlet (and other outlets on the same circuit), limiting your exposure time.

GROUND FAULT CIRCUIT INTERRUPTER (GFCI)

	NOTE
If an outlet doesn't work, check the GFCI. Reset it if necessary. If the GFCI continues to trip, have the motor home electrical system checked at an authorized Fleetwood Service Center or by a qualified electrician.	

ELECTRICAL SYSTEMS

**Test the GFCI at least once a month.
To test the GFCI:**

1. Connect to 120-volt AC.
2. Push the **TEST** button. The **RESET** button should pop out, indicating that the protected circuit has been disconnected.
3. To restore power push the **RESET** button.

Your *Owner's Information Package* contains a card that can be used to record test dates. Keep the card in a conspicuous place, and keep it up to date.

 **WARNING**

Do not install 12-volt fuses or 120-volt breakers with amperage ratings greater than that specified on the device or label. Doing so constitutes a fire hazard.

 **WARNING**

If the "reset" button does not pop out when the test button is pushed, a loss of ground fault protection is indicated. Do not use any electrical outlets. Have the motor home electrical system checked at an authorized fleetwood service center or by a qualified electrician. Do not use the system until the problem has been corrected.

The 120-volt circuit breakers and 12-volt fuses are located in the same compartment. These devices interrupt the power if the circuit is overloaded.

The 120-volt circuit breakers include a 30 amp main breaker and several smaller breakers for individual circuits. If a circuit breaker is tripped, look for an overload on that circuit, then reset it by turning the breaker OFF and then turning it ON. Do not try to reset a breaker the second time without locating the overload problem.

The 12-volt fuses protect individual circuits. If the circuit is overloaded, it will blow the fuse and the fuse must be replaced. Check the circuit for an overload and replace the fuse with the same type and amperage rating.

COACH FUSES AND CIRCUIT BREAKERS

 **WARNING**

Do not install 12-volt fuses or 120-volt breakers with amperage ratings greater than that specified on the device or label. Doing so constitutes a fire hazard.

GENERATOR

Your motor home may be equipped with a gasoline-powered generator which will provide complete electrical self-containment when regular public utility AC power is unavailable. Controls are at the generator and at a remote control panel located inside the motor home.

With the generator operating, and the power cord plugged into the receptacle, power is available at all of the 120-volt power outlets in the motor home, just as if the cord were connected to an external source. The generator is also connected to the power converter, thus supplying 12-volt power as well.

Gasoline for the generator is taken from the main fuel tank through a special feeder tube which is higher in the tank than the feeder tube to the motor home. This arrangement prevents the generator from running the motor home fuel tank dry.

GENERATOR FUEL SUPPLY

To start the generator:

1. Hold the switch in the START position until the unit starts.
2. Then release the switch. If the unit is slow to start, DO NOT hold the switch in the START position for more than 10 seconds.
3. Release the switch, wait 15 seconds, then repeat. This will help avoid overheating and damage to the generator starting system.

To stop the unit:

Hold the switch to the STOP position until the engine stops. If you release the switch too soon, the engine will continue to run.

GENERATOR OPERATION

✓ NOTE

Refer to the generator operating instruction manual provided in your **Owner's Information Package** for information before starting the generator. Do not start the generator unit with a heavy power load. Always wait at least three minutes after starting generator before turning on (or plugging in) heavy electrical loads, such as the roof air conditioner.

ELECTRICAL SYSTEMS

Read and understand the generator operating, maintenance and safety instructions furnished in your *Owner's Information Package*.

- » Do not smoke or use an open flame near the generator unit or fuel tank.
- » Do not use generator ventilating air for heating any interior living space. Ventilating air can contain high concentrations of lethal gases.
- » Check engine fuel lines often. Fuel leakage in or around the compartment is an extreme fire hazard. Do not use the generator until fuel leaks are repaired.
- » Be aware of exhaust gas (carbon monoxide) poisoning symptoms. Refer to section on *Carbon Monoxide Safety Precautions* in the *On The Road* chapter.
- » Check the generator exhaust system after every 8 hours of operation and whenever the system may have been damaged, and repair any leaks or obstructions before further operation. Disconnect the battery before performing any maintenance on the generator. Allow the generator to cool sufficiently before performing any maintenance.

GENERATOR OPERATING SAFETY PRECAUTIONS

! WARNING

Exhaust gases are deadly. Inspect the generator exhaust system thoroughly before starting the generator engine. Do not block the tail pipe or situate the motor home in a place where the exhaust gases have any possibility of accumulating either outside, underneath, or inside your vehicle or any nearby vehicles. Outside air movements can carry exhaust gases inside the vehicle through windows or other openings remote from the generator exhaust. Operate the generator only when safe dispersion of exhaust gases can be assured, and monitor outside conditions to be sure that exhaust gases continue to be dispersed safely.

! WARNING

Do not place flammable material or store any other materials in the generator compartment.

! WARNING

Do not block the generator ventilating air inlets or outlets. The engine requires a constant supply of cooling air. Restricted ventilating air inlets or outlets can cause engine failure or fire from engine overheating.

! WARNING

Do not operate the generator when parked in or near high grass or brush. Exhaust heat may cause a fire.

Do not modify the generator installation or exhaust system in any way.

Do not use the generator as an emergency power source to a general residential or industrial utility line. This is illegal and may result in shock or electrocution to power line utility personnel attempting repairs to the power lines.

! WARNING

Do not under any circumstances operate the generator while sleeping. You would not be able to monitor outside conditions to assure that generator exhaust does not enter the interior, and you would not be alert to exhaust odors or symptoms of carbon monoxide poisoning.

Because of the many model, floor plan and option variations available, it is beyond the scope of this manual to include all wiring diagrams possible. In certain situations, specific wiring diagrams may be available to help troubleshoot a problem. If you need specific wiring information, please contact your dealer. Complete wiring diagrams are not available.

ELECTRICAL SYSTEM WIRING

This page intentionally blank.

LP GAS SYSTEM

Liquefied petroleum (LP) gas is available from an approved storage tank to operate your range, oven, furnace and water heater, and as an alternate energy source for some refrigerators. With proper handling precautions, LP gas is safe and provides modern conveniences wherever you travel. LP gas is stored as a liquid under pressure and vaporizes under the control of a pressure regulator.

A typical LP gas tank installation is illustrated below. Although specific details of the system may differ in your motor home, the major components and their relationships will be similar to those shown.

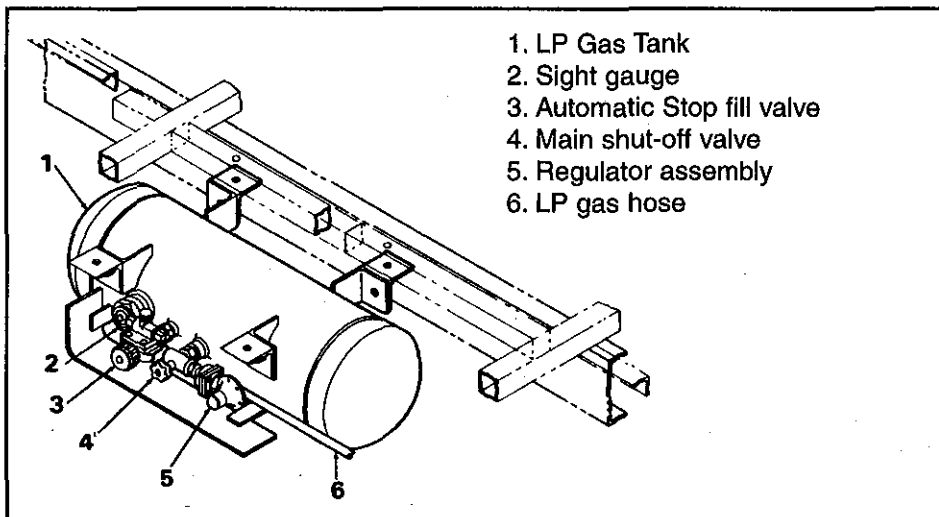

LP GAS SYSTEM

LP gas is a safe and reliable fuel. As with any other volatile and flammable material, common sense dictates that LP gas be handled and used with respect and caution. Because LP gas systems are so reliable, they are often taken for granted. Neglect can be a very dangerous habit. If the system is maintained regularly, you can expect almost trouble-free operation.

LP GAS SAFETY PRECAUTIONS

WARNING

LP gas is flammable and potentially explosive. Use proper handling, lighting and ventilating procedures.

1. The distinctive odor of LP gas indicates a leak. If you smell gas:

Do not touch electrical switches.

Extinguish all open flames, pilot lights and all smoking materials.

Shut off the gas supply at the container valve(s) or gas supply connection.

Open the door and leave the area until the odor clears.

Have the gas system checked by a professional and the cause of the leak corrected before using the motor home again.

2. Inspect the entire LP gas system for leaks or damaged parts before each trip and before filling container. See section on "LP Gas System Leak Checks."

3. Never check for leaks with an open flame. Use an approved leak detection solution or a non-ammoniated, non-chlorinated soap solution only. If the leak cannot be located, take the unit to an LP gas service representative.

4. Always be careful when drilling holes or fastening objects to the motor home. The gas supply lines could be punctured by a nail or screw.

5. Do not restrict access to LP containers. In an emergency, the container service valve must be easily identified and accessible. The container compartment door must always be unlocked, and the LP label should be visible.

WARNING

6. Do not carry or store filled or empty LP gas containers, including accessories such as gas barbecues, in your motor home. LP gas containers are equipped with a safety device that relieves excessive pressure by discharging gas to the atmosphere. Leaks can occur at valves and fittings. Always store LP container outside with the valves closed and plugged.

7. Do not use any LP gas container other than the one furnished with your motor home without being sure that all connecting components are compatible.

8. Turn off LP gas main valve before filling LP gas container or entering an LP gas bulk plant or motor fuel service station. Turn off all pilot lights and appliances individually before refueling of motor fuel tanks and/or LP gas containers. When not individually turned off, automatic ignition appliances may continue to spark when LP gas is turned off at the container.

9. Do not fill LP gas containers to more than 80% capacity. Overfilling can result in uncontrolled gas flow which can cause fire and explosion. A properly filled container holds about 80% of its volume as liquid.

10. LP gas regulators must always be installed with the diaphragm vent facing downward. Make sure that the regulator vent faces downward and that the cover is kept in place to minimize vent blockage which could result in excessive gas pressure causing fire or explosion.

11. Do not use a wrench or pliers to close the container shut-off valve. This valve is designed to be closed leak-tight by hand. If a tool is required to stop a leak, the valve probably needs repair or replacement.

12. If you do not have the special tools and training necessary, do not attempt to repair or modify LP gas system components.

13. Always think safety.

LP GAS SYSTEM

The hoses used in your LP gas system meet *UL* or *CSA* requirements, and are rated to withstand many times the pressures encountered in the system. Although they are designed for efficient and trouble free use, they can deteriorate from impurities in the air. The average life of LP hoses is two to three years. Consequently, check the hoses for weather checking or other signs of deterioration every time you have the gas tank filled or serviced. When you replace hoses, be sure that replacements are properly rated and approved for RV use.

SYSTEM COMPONENTS

HOSES

The regulator is the heart of the LP gas system. It reduces the tank pressure, which can vary from 250 psi to 7 psi, to a steady 6 ounces (11 inches of water column) to serve the appliances in the motor home. It does this in two stages for safety and efficiency.

LP GAS REGULATOR

Because the regulator is constantly “breathing,” it is equipped with a vent. It is very important that the vent stays clean and free from obstruction. Clogging from corrosion, dirt, insect nests or other debris is the most common cause of regulator malfunction. Even a small piece of material that finds its way into the vent can result in improper pressure in the system and possible damage to or failure of components. The regulator is mounted so that the vent is facing downward and is protected from water and dirt by a water-resistant cover. Be sure the cover is on at all times. If the vent becomes clogged, it can be cleaned with a toothbrush. If corrosion is evident, contact a qualified LP gas service technician for a replacement regulator.

	WARNING
Do not attempt to adjust the regulator. It has been preset by the regulator manufacturer. If any adjustment is required, it must be made by a qualified LP gas service technician using special equipment.	

USING LP GAS SYSTEM AT LOW TEMPERATURES

Your LP gas system will function at low temperatures, provided the system components are kept at a temperature above the vapor point of the LP gas. Ask your LP gas supplier or your motor home dealer for information on product blends available in your area and the areas in which you will be traveling.

The following chart shows the reduction in available BTU's/hour under various fill levels as the temperature drops:

20 lb. Tank*					
% FULL	+ 20°	0°	-5°	-10°	-15°
60%	36,000	18,000	12,750	8,500	4,250
50%	32,400	18,200	12,150	8,100	4,050
40%	28,800	14,400	11,400	7,600	3,800
30%	25,200	12,600	10,450	7,300	3,150
20%	21,600	10,800	8,100	5,400	2,700
10%	16,200	8,100	6,075	4,050	2,025

*30 lb. Tank multiply x 1.40

The chart clearly shows how the availability of the gas is reduced at lower temperatures. With this in mind, keep your LP tank as full as possible during cold weather. Check the BTU/hr rating plates on your LP gas appliances. This information will help you manage your LP gas requirements efficiently.

LP gas systems can and do freeze up in very cold weather. It is a common misconception that the regulator or the gas itself freezes. Actually, it is moisture or water vapor that gets trapped in the system or absorbed by the gas that freezes and causes the problem. This ice can build up and partially or totally block the gas supply.

LP GAS SYSTEM

There are a number of things you can do to prevent freeze up:

1. Be sure the gas tank is totally moisture-free before it is filled. If you are not sure, have an LP service station inject an approved antifreeze or deicer into the tank.
2. Be sure the tank is not overfilled. This is also a safety consideration.
3. Have the gas tank purged by the LP gas service station if freeze up occurs.
4. Be sure you have the proper gas blend for your traveling area. If you have the proper gas blend, it is very unlikely that the gas is at fault.

If, despite precaution, you do experience freeze up, ask your LP gas supplier to service the tank or regulator as required.

To fill the storage tank, drive the vehicle to an LP gas supplier or a service station which sells LP gas. Do not attempt to fill the tank yourself.

FILLING LP GAS TANKS

 **WARNING**

Do not fill LP gas containers to more than 80% capacity. Overfilling can result in uncontrolled gas flow which can cause fire and explosion. A properly filled container holds about 80% of its volume as liquid.

 **WARNING**

Turn off LP gas main valve before filling LP gas tank or entering an LP gas bulk plant or motor fuel service station. Turn off all pilot lights and appliances individually before refueling of motor fuel tanks and/or LP gas containers. When not individually turned off, automatic ignition appliances may continue to spark when LP gas is turned off at the container.

LP GAS SYSTEM LEAK CHECKS

The smell of LP gas (actually, an additive, ethyl mercaptan) indicates a leak. Obvious leak sources are fittings, valves and couplings.

For your safety, check for leaks in your gas system each time the tank is filled and before each trip. Always check the system any time you detect a garlic-like odor. Listen for a sustained hiss or hum when you turn the gas on. This may indicate a leak.

The first time you have your LP tank filled, have the serviceman bleed a little LP gas out of the small outage valve (this also lets you check that the tank is not overfilled) and note the odor for future reference. A small number of people cannot smell this odor; if you are one of these you must take extra care in checking for leaks, as well as whenever you use LP gas appliances.

To perform a leak check:

1. Swab a mixture of a non-ammoniated, non-chlorinated soap solution or an approved leak detection solution over each fitting, joint and connection in the system.
2. Open the tank service valve.
3. Inspect each joint.
4. If even the smallest bubbles appear at any joint, this joint must be re-made. Refer repairs to an authorized Fleetwood service center or your LP gas service facility. Never attempt to repair gas piping without proper tools and know-how.

Potential trouble spots for leaks are areas where piping runs close to chassis and frame members. Look for chafes and cracks around pipe hangers. If you find defects in any LP gas system component, have it repaired or replaced before using the system.

	WARNING
Never check for leaks with an open flame. Do not check for leaks using ammoniated or chlorinated household type detergents. These can cause cracks to form on the metal tubing and brass fittings. If the leak cannot be located, take the unit to an LP gas service representative.	

LP GAS SYSTEM

As an added precaution, do a visual check of all exposed piping and fittings after you have arrived at a destination and before you use the LP gas system. Travel and road shocks may have caused damage to the system that you will need to repair before using the appliances.

Keep the tank valve closed and turn off all appliances if the unit is not being used.

A permanently installed LP gas leak detector is located near the floor. The unit contains an alarm that will sound alerting you to the presence of low levels of potentially dangerous LP gas that may have been released due to a gas leak.

The detector unit is powered by the 12-volt DC system in your motor home. A power switch is located on the panel. A green light on the detector front panel indicates that the detector has power.

Test the leak detector each time the motor home is relocated and set up for use.

Testing Procedure:

1. Hold a butane-fueled pocket lighter near the sensor.
2. Open the lighter valve without striking the flame. The leak detector should respond within a few seconds.
3. Switch the unit OFF then ON to reset the alarm.
4. Lightly fan the area around the detector to insure complete dispersion of the gas from the lighter, and to prevent another sounding of the alarm.

If the alarm does not sound during a test or if the green indicator light is not visible, see your dealer or an authorized Fleetwood Service Center. There are no batteries or user serviceable parts inside the unit.

	WARNING
Do not use pliers or a wrench to tighten valves. If a valve is not leak-tight when closed by hand, see an LP gas service representative.	

LP LEAK DETECTOR

	NOTE
<i>Remember to turn off the detector if you are not using your motor home. The detector draws enough current to discharge your battery.</i>	

LIGHTING LP GAS APPLIANCES

Detailed operating information for the LP gas appliances can be found in your Owner's Information Package. Please read and follow these instructions

Air trapped in the gas lines may delay the initial lighting of any appliance. It could take several seconds or minutes for the gas to reach the appliance. To purge some of the air from the gas system, first light a burner on the range. The other appliances will then light more quickly.

We recommend lighting the pilot light at the range, if equipped, rather than individually lighting each burner. This will help prevent accidental leaks at the burner. Be sure the pilot light is extinguished while traveling.

The first time the furnace or oven is operated, paints and oils used in its manufacture may generate some smoke and fumes. If this occurs, open doors and windows to air out the motor home. These materials should burn off after the first 15 to 20 minutes of appliance operation.

Always follow the appliance manufacturer's lighting and operating instructions.

This page intentionally blank.

APPLIANCES

The appliances installed in your motor home are tested by independent laboratories and comply with rigid standards established by these organizations. All appliances are covered by Fleetwood's *Ownercare Warranty* program. Each appliance is also warranted by its manufacturer.



NOTE

The individual appliance manuals included in your **Owner's Information Package** contain detailed operating and maintenance instructions. Always refer to the respective manual for the appliance in question.



WARNING

The water heater and furnace combustion air exhaust ports may be extremely hot during water heater and furnace operation. Do not touch these outlets or allow any material to come within close proximity of exhaust ports while operating the water heater and/or furnace.

The water heater operates on LP gas, and is much like the one in your home. It contains an automatic shut off valve, which stops the gas supply if the water temperature rises too high. The water heater is reached through an access panel on the outside of the motor home.

Turn on the hot water faucet at the galley sink. If water flows continuously, the heater is full.

WATER HEATER



CAUTION

Do not light water heater until it is filled with water.

Appliances

Consult the operating instructions furnished in your *Owner's Information Package*. Before operating the refrigerator when the motor home is parked, make sure it is level. If it is not level, the refrigerant will not circulate, cooling action will stop, and the refrigeration system may be damaged.

The refrigerator uses the absorption principle of operation. If you plan to cool food or drinks in high outside temperatures, pre-cool the food, and park the motor home with the refrigerator vent door in the shade. Once the interior of the refrigerator is cool, the refrigeration system will usually maintain this temperature. If the inside of the refrigerator is hot, the food is not pre-cooled, and the outside temperature is high, be prepared for longer cooling times.

Some refrigerator models are equipped with a decorative enamel door panel. Use a cleaner specially formulated for enamel and a soft cloth to clean this surface. Do not use harsh or abrasive detergents or cleansers.

The forced-air furnace is fueled by LP gas. All furnaces are equipped with a wall thermostat for individual temperature settings.

The furnace will not operate properly if your stored personal items block the free flow of air at the registers or the return air to the furnace. Storage under cabinets should be done carefully so as to not crush or damage the furnace ducting.

Smoke and fumes created as a result of burning off manufacturing compounds are sometimes present the first time the furnace is used. This is normal; however, the initial light off should be done with windows and doors open and be of adequate duration to completely burn off the residue.

REFRIGERATOR

REFRIGERATOR DOOR PANELS

FURNACE

If the furnace is unable to keep you comfortably warm, **NEVER** use the range, oven or a catalytic heater for supplementary heat—even with a vent or window open.

The RV furnace is designed to get its combustion air from outside the RV and discharge the products of combustion to the outside again for safe operation. Open flames in the RV can deplete the available oxygen in the vehicle and replace it with carbon monoxide. The use of the range or oven for the short periods necessary for cooking or baking should present no problem **IF** you also open a vent or window to provide ventilation whenever they are used, assuming you are also alert and awake.

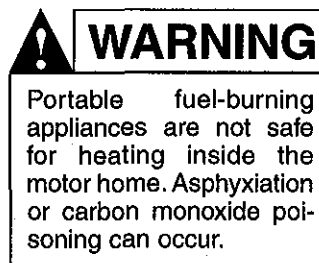

The gas oven and burners are operated with LP gas. The basic operation is the same as the range in your home.

RANGE

A warning label has been located in the cooking area to remind you to provide an adequate supply of fresh air for combustion. Unlike homes, the amount of oxygen is limited in an RV due to the size and construction of the vehicle. Proper ventilation when using the cooking appliances will prevent the dangers of asphyxiation. Refer to *Lighting LP Gas Appliances* section in the *LP Gas System* chapter of this manual.

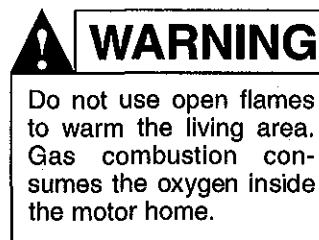

Appliances

The exhaust hood allows vapors and cooking odors to escape, and provides a vent for the galley area. Switches for the fan and light are located on the front of the hood. The hood has a grease filter screen which requires periodic cleaning. To clean, remove the screen and wash in soapy water. Rinse with water and let the screen dry before replacing it. The fan blades may also be cleaned with soapy water. Replace the light bulb with an equivalent type.

The range hood may also house the monitor panel. Operating instructions for the monitor panel functions are in the *Living With Your Motor Home* chapter of this manual.

RANGE HEAD EXHAUST HOOD

The optional roof-mounted air conditioner can operate only when the motor home is connected to 120-volt AC power from either a public utility or the generator. Be sure to turn the air conditioner circuit breaker ON.

For best performance, park the motor home in the shade and close curtains. Close doors and windows. Set thermostat for desired coolness. Refer to the air conditioner manufacturer's instructions for detailed operating and preventive maintenance requirements. Remember that air conditioners use a large portion of your available electrical power.

DUCTED AIR CONDITIONER (IF EQUIPPED)

Appliances

If additional equipment requiring 12-volt power is installed in the motor home, obtain the 12-volt source from a properly fused battery circuit. Consult an authorized Fleetwood dealer before adding any additional equipment to your motor home.

ENTERTAINMENT EQUIPMENT

The optional 120-volt TV and VCR can operate only when the motor home is connected to 120-volt power from either a public utility or the generator.

120-VOLT TV AND VCR (IF EQUIPPED)

The optional 120-volt/12-volt television can operate from a 12-volt power source (battery) as the motor home is delivered. Care should be taken so the batteries are not drained while using the TV on 12-volt power.

120/12-VOLT TELEVISION (IF EQUIPPED)

The television can also be operated on 120-volt power from the generator or public utility by removing the 12-volt cord from the rear of the TV and installing the 120-volt cord. Both 120- and 12-volt cords cannot be used at the same time. To use TV on 12-volt power, the cords must be exchanged.

The roof-mounted antenna is designed for reception of VHF and UHF television signals.

TV ANTENNA

Before traveling, remember to lower the antenna and secure it to prevent damage to the antenna, motor home roof, or objects in the path of the antenna, such as overhead wires.
Do not travel with the antenna raised.

	NOTE
<i>The antenna booster power supply must be turned off to prevent battery drain. A red indicator light will glow when the unit is on.</i>	

Appliances

The television and radio systems in your RV have been chosen to provide good performance under varied signal conditions. Occasionally, though, you may experience *ghosts* on TV, *flutter* when listening to FM broadcasts, or other signal interference.

The fault is normally not with your receiver. Neither is your antenna system usually at fault. The idea that antennas, whether amplified or unamplified, “pull in” a signal is a popular misconception. An antenna does not pull a signal out of the air by virtue of its “power.” The antenna only responds to signals present at the antenna elements. Antennas with boosters only amplify these signals.

Since distance from the broadcast tower is critical to reception clarity, remember that TV and FM signals have a range of only about 75 miles under the best of atmospheric and geographic conditions. The good reception you get at parks located at great distances from broadcast facilities is probably the result of satellite, microwave or other cable distribution systems. The antenna on your RV is no competition for these very expensive installations.

In addition, TV and radio frequency interference results from the electromagnetic fields produced by electric arc discharge. This arcing is found in lightning, vehicle ignition systems, and in 12 volt DC (brush type) motors used in power vents and furnaces. Note that nearly every DC motor has brushes. Most alternating current (AC) motors do not have brushes, and therefore do not generate the arcing interference. This is why this type of interference is less noticeable in a household environment.

TV AND RADIO INTERFERENCE

As the signal diminishes with distance and geographical features (mountains, etc.), the effect of electric arc interference may become more and more noticeable. Eventually, the signal will be overcome by the interference. The following suggestions can improve reception:

- » Use the "park cable" TV antenna system of your RV in remote areas rather than the roof antenna if the campground provides cable hook-up. (Turn off antenna booster when using park cable.)
- » Turn the television antenna. Sometimes turning the antenna will pick up a stronger signal. Try turning or rotating the antenna throughout its range. You may find your signal in a very unexpected direction.
- » With FM stereo signals, switch the unit to MONO, if possible. Some of the phase and noise components of a stereo signal will disappear in MONO mode. Many FM stereo tuners are equipped with a "program adaptive blend" circuit. This circuit senses the condition of the RF signal. If the signal is too weak or contaminated with multipath reflections to be received in stereo without objectionable noise or distortion, the radio will automatically blend its stereo decoder toward mono. The radio will constantly vary its reception from full stereo to mono depending on the reception conditions. This variation and blending is built into the radio's circuitry and happens automatically without requiring intervention by the listener.
- » Reduce the treble setting to reduce background noise. Although not yielding the best high-frequency performance, at least you may be able to reduce the irritation of the distortion and noise.

You may have additional appliances in your unit which operate only when connected to 120-volt power from either a public utility or the generator.

In some cases appliance selector switches are provided on the galley to allow you a selection of appliances yet still remain within the power capacity of the electrical system.

MISCELLANEOUS APPLIANCES

This page intentionally blank.

MAINTENANCE

Your motor home has been designed to provide you with many years of use with a minimum amount of maintenance. This section will familiarize you with the areas of your motor home that require scheduled care. Time spent taking care of your motor home on a regular basis will pay for itself in extended service and will help protect your investment. If you are mechanically inclined and regularly perform routine maintenance and repairs on your car or truck, you may want to do the mechanical work on your motor home yourself. If you prefer, your dealer can perform these services for you. His trained personnel will assure that your motor home is maintained and repaired in keeping with original performance expectations.

This section is intended to provide the owner and operator with a general overview of service and maintenance information for the motor home. Detailed service and maintenance information may be found in the owner's/operator's manuals contained in the *Owner's Information Package*.

While the information in this section is intended to establish proper maintenance and inspection procedures, there may be times when detailed diagnostic and repair procedures may be required. Consult your dealer or an authorized Fleetwood Service Center in these situations.

MAINTENANCE

Some exterior parts of your motor home are made of fiberglass. The finish on these parts is durable, but not indestructible. Any material and finish will deteriorate in time. Exposure to sunlight, moisture and airborne pollutants can cause dulling and fading of the finish. Generally, changes in the finish due to weathering are cosmetic — they are on the surface of the part and do not affect its strength. Weathering can take the form of chalking, fading and yellowing.

The best insurance against these effects is routine maintenance. If the finish is not washed and waxed thoroughly, the surface can deteriorate very rapidly. The following maintenance guidelines can help you reduce these weathering effects:

1. Wash the exterior with a mild soap monthly, at least. Avoid strong alkaline cleaners and abrasives.
2. Wax the exterior at least once a year — twice, if possible — with a wax formulated for fiberglass. When waxing, always read and follow the instructions and precautions on the container. Some cleaners and waxes are recommended for use on only certain types of surfaces. In some cases, a light rubbing compound may be required. Always follow rubbing compound with a high-quality wax.

EXTERIOR

Stains are generally caused by two types of substances — water soluble and non-water soluble. Water soluble stains can usually be washed away with water and mild detergent. Follow the washing with wax.

STAINS

Non-water soluble stains are usually oil-based. Removal of this type of stain may require the use of highly flammable or poisonous solvents. Refer this type of service to your dealer or an authorized Fleetwood Service Center. Never use strong solvents or abrasives to clean plastic surfaces.

WINDOWS, DOORS, VENTS AND LOCKS

Keep moving parts, hinges and latches adjusted and maintained. Lubricate with a light oil at least once a year. Check and tighten the screws holding the windows in place as required. Clean screens by gently wiping with a damp cloth or soft flat brush. Not all screens are removable.

Inspect the sealants around doors and windows every three months. See Sealant Renewal section.

Lubricate locksets in doors and exterior storage compartments at least annually with powdered graphite. If the motor home is located at a beach or is exposed to salt air, more frequent lubrication may be required.

For normal cleaning, standard household detergents or cleansers may be used. Use a non-abrasive, common household detergent and plenty of water. Be sure to keep the sidewalls wet to reduce streaking. Road tar, tree sap or other stubborn stains can be removed with a soft rag and xylene.

RUBBER ROOF SYSTEM CLEANING

 **WARNING**

Xylene is a flammable liquid. Use extreme care when handling and using. Do not expose to open flame, spark or smoking material. Do not use in unventilated area.

The rubber roof itself does not require annual coatings or additional sealants. Periodic washing with soap and water is all that is required.

CARE

The rubber roof material can be cut by sharp objects. If you add accessories or new equipment on the roof, be sure the installer is qualified to work on the rubber roof material. This is required under the terms of the warranty.

 **WARNING**

Rubber roof material is slippery when wet.

Repair kits are available through your dealer. The roof requires special adhesives and material.

MAINTENANCE

SEALANT RENEWAL

The adhesives and sealants used in the construction of your motor home were developed to remain waterproof under sustained effects of weather and vibration. However, even the finest materials will eventually dry out and lose their effectiveness under constant heat of the sun and attack by other elements. **This section outlines the procedures you must follow to maintain the weatherproof integrity of your motor home. Leak damage caused by failure to inspect and maintain the roof, vents, TV/satellite antenna and molding seals may affect your warranty coverage.**

Your dealer can perform the resealing inspection and work for you. Your dealer also has current information on sealants used in your motor home, and can recommend the appropriate sealants for you if you prefer to do this work yourself. Always use the recommended sealants.

Inspect the sealants around windows and doors at least every three months. Also inspect roof vents, other roof components, moldings at front and rear caps, and perimeter molding. If any of the following defects are evident during inspection, the affected areas must be resealed.

- » Excessive amount of sealant protruding from joints.
- » Sealant cracked or peeling.
- » Voids in sealant.

If you find any of the above defects:

1. Use a plastic scraper to remove excess sealant, any cracked or peeled sealant, or any voids in the sealant.
2. Clean all areas to be resealed with mineral spirits and clean rags.
3. Make sure that all areas to be resealed are absolutely dry before new sealant is applied.

DOOR, WINDOW, ROOF COMPONENT AND MOLDING RESEALING



NOTE

Do not seal the bottom flanges of windows and doors. Sealant voids have been intentionally left in the bottom flange to provide exterior drainage in the event of leakage.



WARNING

Mineral spirits is a flammable liquid. Use extreme care when handling and using. Do not expose to open flame, sparks, or smoking material. Do not use in unventilated areas.

Interior appointments such as draperies, bedspreads, mattress covers, upholstery and wall pads are manufactured from high quality synthetic materials and should be dry cleaned only. Frequent vacuuming will keep them free of dust and dirt. Minor spills should be cleaned up quickly to avoid staining. The affected area should be blotted, not rubbed, to prevent the stain from working deeper into the fabric.

INTERIOR

FABRICS



WARNING

Do not use lacquer thinner, nail polish remover, carbon tetrachloride, spot remover, gasoline, or naphtha for any cleaning purpose. These products may cause damage to the material being cleaned, and may be highly flammable or poisonous.

For cleaning laminate surfaces, use a mild dishwashing liquid with warm water. Use a soft cloth for both washing and drying.

LAMINATE TOP CARE

Do not use abrasive cleaners, steel wool, or gritty cleaners or damage will occur to the surface.

The paneling and the ceiling of your motor home may be any of several finishes and textures. Never use harsh detergents or abrasive cleaners on walls or ceilings. Most surfaces will clean with a soft cloth moistened with mild liquid detergent in warm water. Do not use large amounts of water which could saturate the material.

WALLS AND CEILING PANELS

MAINTENANCE

Some cleaners attack the plastic causing it to discolor and become brittle. The following cleaners have been tested and approved when mixed with water: Distilled vinegar, mild dishwasher detergent, or liquid deodorizing cleaner. Avoid cleaners with any level of abrasives, acetone or MEK (methyl ethyl ketone).

BATHTUB AND PLASTIC SHOWER STALL

Vinyl flooring requires only washing and periodic waxing. Vacuum carpeting regularly, and clean it with a quality carpet cleaner. Do not use water or waxes mixed with water on wood floor.

FLOORS AND CARPETING

The top of the engine may be accessed for service by removing the engine cover.

ENGINE ACCESS



WARNING

When installing the engine cover, be sure the cover is fully seated on the gasket seal and secured by the cover screws or clamps. Do not allow carpeting, floor mats or other material to interrupt the seal between the cover and the engine compartment. If the engine cover is not installed correctly, engine exhaust gases could leak into the passenger compartment creating a safety hazard. If the engine must be run with the engine cover off for maintenance purposes, be sure the vehicle interior is adequately ventilated.

For your convenience, a maintenance checklist is included in this manual. This comprehensive list is the most up to date available at the time of publication. Options and accessories usually have their own owner/user manuals that often contain added maintenance instructions. Consult these manuals as required.

MAINTENANCE CHECKLIST

MAINTENANCE CHART

	A	B	C	D	E	F	G	H	I	J
Wash exterior		●								
Wax exterior						●				
Lubricate and adjust exterior locks, hinges and window mechanisms							●			
Lubricate TV antenna	●					●		●		
Check all exterior sealants, around windows, doors, sidewall seams, windshield, lamps, all exterior openings and roof components. Re-seal if necessary.	●				●			●		
Inspect and clean fuel-fired appliance vents: Water heater, refrigerator, furnace.	●			●			●	●		
Inspect and test safety equipment: Fire extinguisher, LP, CO and smoke detectors/alarms, and GFCI receptacles.		●								
Service appliances and equipment: refrigerator, roof air conditioner, furnace, generator	●								●	
Inspect generator exhaust system		●								
Inspect LPG system including leak check	●	●						●		
Sanitize fresh water tank	●				●					
Clean drapes and interior fabrics	●					●				
Check exterior lamp operation	●					●				
Re-torque U-bolts (Mor-Ryde equipped only)									●	
Chassis										●

A - Start of Season

B - Each Trip or Monthly

C - Every 8 Hours

D - Weekly

E - Every 3 Months

F - Every 6 Month

G - Each Year

H - End of season

I - At Specified Mileage or Interval

J - At Specified Mileage for Heavy Duty Service

This page intentionally blank.

STORAGE

The following checklists will help you perform the steps necessary to prepare your motor home for storage. Use the checklist that applies to the storage conditions you anticipate.

STORAGE CHECKLISTS

These checklists do not include every detail required, and you may want to expand them to suit your needs. Contact your dealer for additional suggestions suitable to your climate and storage conditions, particularly extremes of hot and cold.

-
- Wash the motor home exterior and underside. Hose off accumulations of mud and road salts.
 - Thoroughly clean the interior of the motor home, including carpets, counter tops, lavy, tub and shower, and galley.
 - Inflate tires to maximum rated cold pressure.
 - Park the motor home as level as possible front to rear and side to side. Block wheels front and rear, and leave the parking brake OFF.
 - Check the charge in the battery. Recharge as necessary.
 - Remove battery cables. Refer to *Chassis Operator's/Owner's Guide/Manual* for proper removal and installation sequence. Clean terminals, top and sides of batteries and battery boxes. Reinstall cables, dress with a battery terminal protectant spray.
 - Use battery disconnect switch/es, if equipped.
 - Drain holding tanks, toilet, and fresh water tank.

SHORT-TERM STORAGE (LESS THAN 60 DAYS)

STORAGE

- Winterize, if appropriate. (See *Winterization* section in this manual.)
- Turn off water pump and water heater master switches.
- Turn off LP gas at tank valve.
- Turn off refrigerator and furnace.
- Turn off all range and oven burner valves and pilot valves (if equipped).
- Remove all perishables from refrigerator and galley cabinets. Block refrigerator open to reduce odor buildup. An open box or tray of baking soda in the refrigerator will help absorb odors.
- Open closet doors, drawers, and cabinets so air can circulate.
- In warm or hot climates, slightly open ($\frac{1}{4}$ ") roof vents, at front and rear for ventilation. If the motor home is being stored below freezing, close and cover all vents to prevent entry of snow, etc.
- Close and lock all windows. Be sure vent fan and range hood fan switches are off.
- Cover exterior appliance vents (water heater, furnace, range hood, refrigerator) to help prevent mice and insects from getting in. Be sure to remove all covering material before using appliances or vents.
- Cap or close holding tank drain, city water inlet and fresh water fill spout.
- Turn off all radios, TVs, interior and exterior lights.
- Close curtains and/or mini-blinds, and pull shades.

STORAGE

- Disconnect the 120-volt power cord, and store in compartment.
- Cover tires with cloth, plywood, or aftermarket tire covers.
- Prepare generator (if equipped). Refer to *Generator Operating Manual* included in your *Owner's Information Package*.
- Run the engine for about 15 minutes every 30 days. Turn the vehicle air conditioner ON during this run. Check engine oil, transmission fluid and coolant levels.

-
- Perform all steps as required for short-term storage.
 - Run engine to normal operating temperature. Operate air conditioner to lubricate compressor seals. Drain engine oil, replace filter, refill engine with fresh oil.
 - Remove windshield wiper blades and store inside the motor home.
 - Charge and remove both the vehicle and auxiliary batteries. Store them in a cool, dry place, and check the charge and water level every 30 days. If the specific gravity is being checked, recharge the battery when it drops to 1.220. The time it takes the battery to reach 1.220 depends on its condition and the temperature. The colder the storage area, the slower the battery will self-discharge. A normal time between charges is three months.
 - Remove, clean and replace air conditioner filters. Cover the air conditioner shroud(s).
 - Winterize, if appropriate. (See *Winterization* section in this manual.)

LONG-TERM STORAGE (OVER 60 DAYS)

✓ **NOTE**

If your motor home is equipped with a solar battery charger, it will trickle charge both house and automotive batteries. The battery disconnect switch must be ON for the solar charger to charge the batteries.

STORAGE

- Cover the windows on the inside with foil, cardboard, paper, etc., to reduce curtain, drape, and carpet fading.
- Cover the external refrigerator, water heater and furnace vents. This will help prevent mice and insects from building nests that can disrupt the air flow and keep appliances from functioning properly.
- Remove batteries in clocks or other battery-powered devices.
- During extended periods of storage, gasoline may deteriorate due to oxidation. This can damage rubber and other materials in the fuel system. It may also clog small orifices. Consider adding a commercial gasoline fuel stabilizer if you expect storage periods to exceed 60 days. Follow the additive manufacturer's instructions. Operate the vehicle regularly during the storage period to mix and circulate the anti-oxidant agent throughout the fuel system.
- Check tire inflation pressures every 30 days. Maintain maximum rated cold inflation pressure.
- Check the sealant around all roof and body seams and windows. Reseal if necessary. See *Sealant Renewal* section.
- Lubricate all locks and hinges as described in the *Maintenance* chapter.
- Remove high grass or weed growth.

WINTERIZATION

Thoughtful planning and preparation for the winter season can help eliminate equipment failures and breakdowns, and can extend the life of your motor home and its systems. Your dealer can advise you concerning specific winterization procedures and products for your climate area or the areas through which you will be traveling. Your dealer may also provide winterization service for all appliances and systems in the motor home. The following is a check list if you prefer to perform these procedures yourself:

- Check engine coolant level and antifreeze protection. Drain and flush engine cooling system and add antifreeze to protect the system to the lowest expected storage temperature or at least -20° F.
- Service and winterize the generator (if equipped) as outlined in the generator operating manual included in your *Owner's Information Package*.
- Winterize the LP gas system. Your LP dealer or service station will perform this for you.
- Winterize all appliances as outlined in the individual operator's manuals.
- Remove snow accumulations as often as possible.

Read this section completely before performing winterization.

WATER SYSTEM WINTERIZING

- Remove water purifier filter cartridge, if equipped, and install the winterizing plug.
- Drain the fresh water tank by opening the water tank drain valve. Leave valve open.
- Turn water pump on (12-volt power must be on). Open a cold water faucet. When the flow of water stops, turn the pump off.

STORAGE

- Open water faucets, then open the drain valves on HOT and COLD water pipes. Leave these valves open.
- Drain the water heater by opening the drain plug at the bottom of the heater and the safety valve at the top.
- Flush the toilet. Operate toilet sprayer, if equipped.
- Drain the shower head by opening the valve. Let all water drain out the tub spout. Leave the valve open.
- When each faucet has been drained, close all faucets, water line drain valves and the fresh water tank drain valve, install the water heater plug and close the safety valve.
- Drain the waste water system by following the normal procedure for draining the holding tanks. (See *Plumbing* chapter).
- Apply silicone lubrication to the knife valve actuator rod(s).
- Be sure ALL water from ALL plumbing fixtures has been drained.
- Close holding tank drain valves.
- Pour approximately five gallons of approved non-toxic antifreeze into the fresh water tank.
- Turn the water pump master switch ON.
- Open each cold water faucet, run the water pump and let about a cup of antifreeze solution flow continuously through each faucet. Close each cold water faucet.
- Flush the toilet until the antifreeze solution flows continuously. Release flush mechanism.

CAUTION

Draining the water system alone will not provide adequate cold weather protection. If the motor home is to be unheated during freezing temperatures, consult your dealer for the best winterizing procedure for your climate. Your dealer can winterize your motor home for you or can supply you with one of the special antifreezes which are safe and approved for use in RV water systems. Follow the instructions furnished with the antifreeze.

WARNING

Do not use automotive or windshield washer antifreeze in the motor home water system. These solutions may be harmful if swallowed.

- If your vehicle is equipped with a water heater bypass, winterize the water heater according to the instructions provided with the water heater operating manual. If you do not have a bypass, you will have to fill the water heater with antifreeze solution by the water pump. Winterize the hot water lines by opening each hot water faucet, allowing antifreeze solution to flow continuously, and then close each faucet. This will require considerably more antifreeze solution, and you may choose to do this step before winterizing the cold water lines so you can recycle the solution.

- When filling the plumbing systems with antifreeze, be sure to open and operate all fixtures and valves allowing the antifreeze solution to flow freely.

- Pour one cup of antifreeze solution down each drain.

- Install all protective caps:
 - Water tank fill
 - City water inlet cap
 - Waste tank drain outlet cap

- If your refrigerator is equipped with an ice maker, winterize it as follows:
 1. Shut off the water supply valve to the ice maker.
 2. Place a shallow pan under the water solenoid valve.
 3. Remove the inlet fitting to the ice maker water solenoid valve. Drain the water from the supply line.
 4. Remove the plastic nut and water line from the outlet side of the water solenoid valve. Drain water from the line.
 5. Cycle the ice maker several times while blowing compressed air through the water solenoid valve. Be sure all water is out of the solenoid. **NOTE: Your motor home dealer can do this for you.**
 6. Reconnect and tighten the lines on the solenoid valve. Leave the water supply turned off until temperatures are above 32°F/0°C.
 7. Dry out the ice maker mold assembly with a soft cloth. Place the bail arm to the **UP/OFF** position.

STORAGE

If the motor home was properly and carefully prepared for storage, taking it out of storage will not be difficult. The following procedure check list assumes that you stored the motor home with care. If you didn't, and extensive freeze damage or other serious deterioration has occurred, please consult your dealer or an authorized Fleetwood Service Center for advice.

REACTIVATING THE MOTOR HOME AFTER STORAGE

- Thoroughly inspect the outside of the vehicle. Look for animal nests in wheel wells, under the hood, in air cleaner or in other out of the way places.
- Remove all appliance vents, ceiling vent and air conditioner coverings. Be sure all furnace, water heater, and refrigerator openings are clear and free of debris or insect nests, webs, etc.
- Open all doors and compartments. Check for animal or insect intrusion, water damage, or other deterioration.
- Check all chassis fluid levels — engine oil, engine coolant, power steering fluid, brake fluid, transmission fluid, rear axle oil.
- Check charge level in batteries. Refill and recharge as necessary. Reinstall batteries if necessary. Be sure cable ends and terminals are clean and free of corrosion.
- Check tire pressures. Reinflate to specified cold pressure.
- Remove covering from inside windows.
- Open vents and windows for ventilation.
- Be sure engine instruments indicate proper readings. Run engine up to operating temperature. Shut engine down. Check all fluids. Top off if necessary.

- During engine run, check the operation of headlights, tail-lights, turn signals, backup lights, clearance lights, license plate light, emergency flashers. Operate the vehicle air conditioner. If air conditioner does not work, or unusual sounds occur, have the system checked by a qualified air conditioner technician.
- Drain, flush, and sanitize the fresh water system as outlined in the *Plumbing* chapter. Inspect the drain hose for leaks. Replace if necessary — repairs are usually not effective.
- Install a new water purifier cartridge (if equipped).
- Operate all faucets and fixtures in the fresh water system. Check for leaks at all joints and fittings. Repair if necessary.
- Check 12-volt circuit breakers and inspect fuses.
- Operate all 12-volt lights and accessories.
- Install new batteries in battery-operated devices. Check operator's manual for each device for additional requirements.
- Test carbon monoxide, LP gas and smoke detectors/alarms.
- Check monitor panel operation.
- Open and operate vents and vent fans, including the range hood fan.
- Inspect the 120-volt electrical system — power cord, converter, all outlets, and any exposed wiring. If defects are found, refer service to your dealer or an authorized Fleetwood Service Center.

STORAGE

- Prepare the generator for operation following instructions in the generator operating manual in your *Owner's Information Package*.
- Start and run generator.
- Operate 120-volt appliances and air conditioners. Be sure to uncover air conditioner shroud(s).
- Inspect the LP gas system and check for leaks as described in the *LP Gas System* chapter. If the LP tank shows signs of rust or corrosion, have it inspected by a qualified LPG technician.
- Operate each LP gas appliance. Observe all burner/pilot flames for proper color and size. In any case, have the LP gas regulator adjusted for proper pressure by a qualified technician.
- Inspect and clean the interior.
- Check the sealant around all roof and body seams and windows. Reseal if necessary. See *Sealant Renewal* section.
- Lubricate all exterior locks, hinges, and latches.
- Reinstall windshield wiper blades or remove protective covers. Check wiper/washer operation.

- Wash and wax the exterior. Inspect the body for scratches or other damage. Touch up or repair as necessary. Flush the underside thoroughly.
- Run thorough operational checks of steering, brakes, engine and transmission. Operate vehicle slowly during these checks to allow sufficient circulation of fluids and reseating of components.

Your motor home should now be ready for a new traveling season. If you choose, your dealer can double check your preparation and correct any defects or make any necessary adjustments.

This page intentionally blank.

GLOSSARY

AC INVERTER - An electronic device that changes 12-volt DC energy from the batteries to 120-volt 60-cycle, AC energy to operate microwave ovens, TVs, VCRs, or other appliances that require 120-volt 60-cycle power.

Belted Seating Positions - These are seats with seat belts. Anyone riding in the motor home must use one of these seats any time the motor home is in motion.

Black Water Tank - The water tank in your plumbing system that is designed to contain waste water from the toilet ONLY.

CAUTION - Any statement in this *Owner's Manual* that, if not followed, could result in damage to the vehicle or components.

Chassis Operator's/Owner's Guide/Manual - This is the operating and maintenance manual supplied by the chassis manufacturer. It is part of your *Owner's Information Package*. It contains information on operating and maintaining the engine, transmission, drivetrain and other components of the motor home chassis.

DC CONVERTER - An electronic device that changes 120-volt AC energy from the main power connection or the generator to 12-volt DC energy to operate the 12-volt interior lights or other 12-volt DC appliances or accessories.

Designated Seating Capacity (CANADIAN UNITS ONLY) - The number of sleeping positions designated equals the seating capacity.

Doorside - The right side of the motor home from the driver's point of view. So named because the main entry/exit door is usually on this side.

FIN (FLEETWOOD IDENTIFICATION NUMBER) - This is the number that identifies your motor home as a Fleetwood product. Use this number when ordering parts or requesting warranty service for your motor home.

Glossary

GAWR (Gross Axle Weight Rating) - The maximum permissible loaded weight a specific axle is designed to carry.

GCWR (Gross Combined Weight Rating) - The value specified by the motor home manufacturer as the maximum allowable loaded weight of this motor home with its towed trailer or towed vehicle. Towing and braking capacities may be different. Refer to Fleetwood and the chassis manufacturer's manuals for complete information.

GEAR PRESELECTION - The selection of a lower gear to match the driving conditions you encounter or expect to encounter. Preselection will give you better control on slick or icy roads and on downgrades. Downshifting to lower gears increases engine braking. The selection of a lower gear often prevents cycling between a gear and the next higher gear on a series of short up-and-down grades.

GFCI (Ground Fault Circuit Interrupter) - An electrical device attached to the bathroom AC circuits that disconnects the outlet if a problem occurs in the ground circuit.

GRAY WATER TANK - The water tank in your plumbing system that is designed to contain waste water from the sinks and shower drains ONLY. No toilet wastes go into this tank.

GTW (Gross Towing Weight) - The maximum permissible loaded weight of a trailer or car that this motor home has been designed to tow. This cannot be increased by changing the trailer hitch.

GVWR (Gross Vehicle Weight Rating) - The maximum permissible weight of this motor home. The GVWR is equal to or greater than the sum of the Unloaded Vehicle Weight plus the Net Carrying Capacity.

MONITOR PANEL - An electronic device that allows you to conveniently measure the approximate levels in the fresh water, gray and black water tanks. You can also check the charge in the battery/batteries.

NCC (NET CARRYING CAPACITY) - The maximum weight of all occupants including the driver, personal belongings, food, fresh water, LP gas, tools, the tongue weight of towed vehicle, dealer installed accessories, *etc.*, that can be carried by this motor home. Normal variation of materials may cause the Net Carrying Capacity to be 200 lbs. higher or lower than stated. (NCC is equal to or less than GVWR minus UVW.)

NOTE - A statement or instruction in this *Owner's Manual* with information to help you use the vehicle or equipment more efficiently, such as a tip.

OWNER'S INFORMATION PACKAGE - This is a package of papers, manuals, warranty and instruction cards, and other material put together for you by Fleetwood. These materials contain operating and maintenance instructions for most of the components and appliances in your motor home.

OWNERCARE CARD - The card that has your name and vehicle ID (FIN) embossed on it. Use this card when you request or need warranty service. Please note that this is NOT a credit card. You cannot purchase anything with it. It is used only to identify you and your motor home.

PARK CABLE - The F-style video connector that allows you to connect to an outside television signal source, such as the cable TV feed at an RV park, or any other 75-ohm video source. This connector usually carries an RF modulated signal.

Glossary

Park/City Water Connection - The “garden-hose” style connector that allows you to connect to an outside pressurized water source.

Power/Shore Cord - This is the main power cord coming into your motor home electrical system. You connect it to 120-volt AC power at a park or campsite.

Predelivery Inspection - This is the procedure required by Fleetwood that your dealer performs before you take delivery of the motor home at the time of sale.

Roadside - The left side of the motor home from the driver’s point of view. So named because, at least in North America, the “road” outside the vehicle is usually on this side.

TW (Tongue Weight) - The maximum permissible downward force exerted on the hitch ball by the towed vehicle coupler.

UVW (Unloaded Vehicle Weight) - The weight of the motor home, as built at the factory with full fuel, engine oil and coolants. The UVW does not include cargo, fresh water, LP gas, occupants or dealer installed accessories. **Note: Canadian UVW includes designated seating, LP and water.**

VIN (Vehicle Identification Number) - The legal 17-digit vehicle identification number as shown on the vehicle registration certificate.

WARNING - A statement or instruction in this *Owner’s Manual* that, if not followed, could lead to personal injury or death.